



# VIRTUAL SHEQ WORKSHOP

29 NOVEMBER 2022

PRESENTED BY: PIETER DEMPSEY



**FPS**

**Flame Proof Solutions  
Electrical Contracting cc  
t/a ARK HOLDINGS**

# AGENDA



## Virtual SHEQ Workshop

**Legislative and compliance requirements on Electrical Installations and Hazardous Classification Zoning.**

29 November 2022

[Virtually via MS Teams](#)

## Programme

10:00 – 10:10

### Opening and welcome

*Gerard Ramage: SHEQ Manager, VKB Group*

10:10 – 11:45

### What does the OHS Act (Act 85 of 1993) say about electrical compliance?

What distinguishes normal electrical installations from specialised electrical installations?

Where to begin if you think you have areas in your plant/facility that could qualify as hazardous locations which require specialised electrical installations

### Training session: Introduction to health and safety law

*Pieter Dempsey, owner, Ark Holdings*

11:45 – 12:00

**BREAK**

12:00 – 13:00

### Typical elements involved in an electrical compliance drive of specialised electrical installations

**Standards and Codes of Practice: local and international**

*Pieter Dempsey*

### Questions and Answers

13:00

### Closure

*Annelize Crosby, Head: Legal Intelligence, Agbiz*



# WHAT DOES THE OHS ACT (ACT 85 OF 1993) SAY ABOUT ELECTRICAL COMPLIANCE? (PART 1)

- WHERE ELECTRICITY IS GENERATED/DISTRIBUTED/CONVERTED/CONSUMED IT MUST BE DONE IN A MANNER WITHOUT ANY RISK TO: PERSONS/ANIMALS/EQUIPMENT/BUILDINGS..... AND WHICH COMPLIES WITH THE REQUIREMENTS STIPULATED IN THE OHS ACT (ACT 85 OF 1993), THE ELECTRICAL INSTALLATION REGULATIONS AND THE ELECTRICAL MACHINERY REGULATIONS.
- EXCLUDED ARE INSTALLATIONS USING LESS THAN 50 VOLTS, (BUT IF THE SOURCE OF THE 50 VOLTS IS DERIVED FROM A SUPPLY BIGGER THAN 50 VOLTS THEN IT IS INCLUDED), TELECOMMUNICATION SIGNALS, INSTRUMENTATION SIGNALS EXCLUDED
- INCLUDED ARE ALL POWER SOURCES (50 VOLTS AND UP, NO LIMIT ON VOLTAGE) WHETHER ,IMBEDDED (SOLAR , UPS, DIESEL and BIOGAS GENSETS) HYDRO OFF THE GRID OR ON THE GRID

# WHAT DOES THE OHS ACT (ACT 85 OF 1993) SAY ABOUT ELECTRICAL COMPLIANCE? (PART 1)

- IF YOU USE ELECTRICITY THE ELECTRICAL INSTALLATION MUST BE CONSTRUCTED SAFELY SO THAT IT COMPLY WITH RULES AND REGULATIONS (MINING, AGRICULTURE, DOMESTIC, INDUSTRIAL COMMERCIAL, PETROLEUM, ETC. (MINING HAS A SLIGHTLY DIFFERENT SET OF RULES, FOR UNDERGROUND) WIRING FOR TRACTION - (TRAINS), AIRCRAFT, SHIPS ARE NOT INCLUDED
- OWNER USER IS RESPONSIBLE TO ENSURE SAFE USE AND MAINTAINING, CAN TRANSFER THAT RESPONSIBILITY IN WRITING TO A TENANT
- DEPT. OF EMPLOYMENT AND LABOUR, IN PARTICULAR THE CHIEF INSPECTOR FACTORIES ARE THE CUSTODIAN'S OF THE ACT (ACT 85 OF 1993)

# WHAT DOES THE OHS ACT (ACT 85 OF 1993) SAY ABOUT ELECTRICAL COMPLIANCE? (PART 2)

- CHIEF INSPECTOR USES EIR AND EMR AS WELL AS APPROVED SAFETY STANDARDS/CODES OF PRACTICE (SANS) TO ENSURE SAFETY OF ELECTRICAL INSTALLATIONS
- OWNERS / USERS MUST BE IN POSSESSION OF A VALID CERTIFICATE OF COMPLIANCE (COC) FOR THEIR ELECTRICAL INSTALLATIONS IN SOUTH AFRICA AND SOME NEIGHBORING COUNTRIES

# WHAT DOES THE OHS ACT (ACT 85 OF 1993) SAY ABOUT ELECTRICAL COMPLIANCE? (PART 2)

- CoC'S CAN ONLY BE ISSUED BY A REGISTERED PERSON FOR THE CATEGORY OF INSTALLATION HE IS REGISTERED FOR:
  - "REGISTERED PERSON" MEANS A PERSON REGISTERED IN TERMS OF- (A) REGULATION 11; OR (B) REGULATION 9 OF THE **ELECTRICAL INSTALLATION REGULATIONS, 1992**, AS:
    - SINGLE PHASE TESTER = SINGLE PHASE DOMESTIC TYPE INSTALLATIONS
    - INSTALLATION ELECTRICIAN = SINGLE AS WELL AS THREE PHASE INCLUDING DC; DOMESTIC; COMMERCIAL; INDUSTRIAL
    - MASTER INSTALLATION ELECTRICIAN = ALL ELECTRICAL INSTALLATIONS INCLUDING EXPLOSIVE ATMOSPHERES ONES
    - MEDIUM VOLTAGE ELECTRICAL INSTALLATION, (COS) CERTIFICATE OF SAFETY=1001 VOLTS AND HIGHER, REGISTERED PERSON MUST HAVE PROOF OF COMPETENCY TO THE SATISFACTORY OF THE FACTORY INSPECTOR AS FAR AS DESIGN, CONSTRUCT AND TESTING OF THESE TYPES OF ELECTRICAL INSTALLATIONS (ALTERNATIVE ENGINEER RESPONSIBLE)

# WHAT DOES THE OHS ACT (ACT 85 OF 1993) SAY ABOUT ELECTRICAL COMPLIANCE? (PART 3)

- ONLY COMPETENT PERSONS ARE ALLOWED TO WORK ON ELECTRICAL INSTALLATIONS. IF THE USER / OWNER OF AN ELECTRICAL INSTALLATION IS THE EMPLOYER HE HAS TO ENSURE THAT THE IS CONTRACTOR IS REGISTERED AND COMPETENT
- NO ONE MAY DO INSTALLATION WORK UNLESS HE OR SHE DOES THE WORK UNDER THE GENERAL CONTROL OF A REGISTERED PERSON OR HIMSELF OR HERSELF IS A REGISTERED PERSON. THE INTENTION IS TO ENSURE THAT INSTALLATION WORK IS CARRIED OUT UNDER CLEAR INSTRUCTIONS, GUIDANCE AND PROPER SUPERVISION AND THAT IT COMPLIES WITH THE HEALTH AND SAFETY STANDARD
- COC REMAIN VALID UNTIL CHANGES ARE MADE FOR WHICH CHANGES A SUPPLEMENTARY COC HAS TO BE ISSUED.



# WHAT DOES THE OHS ACT (ACT 85 OF 1993) SAY ABOUT ELECTRICAL COMPLIANCE? (PART 4)

- COC'S CAN BE TRANSFERRED FROM SELLER TO BUYER PROVIDED THAT THE CERTIFICATE IS NOT MORE THAN 2 YEARS OLD, IF OLDER THEN THE OLD CERTIFICATE IS NOT TRANSFERABLE AND A NEW CERTIFICATE MUST BE ISSUED
- ELECTRICAL COMPLIANCE INDUSTRY LIKE MANY OTHERS ARE SUFFERING FROM SCAMMERS WITH A TOTAL DISREGARD FOR THE LAW SO MAKE SURE YOU GET A VALID CERTIFICATE OF COMPLIANCE, ISSUED BY A SUITABLE REGISTERED PERSON FOR THE CATEGORY OF INSTALLATION YOU REQUIRE THE COC FOR.

## WHAT DOES THE OHS ACT (ACT 85 OF 1993) SAY ABOUT ELECTRICAL COMPLIANCE? (PART 5)

- EVERY EMPLOYER IS REQUIRED TO PROVIDE AND MAINTAIN A SAFE AND HEALTHY WORKPLACE. TO ACHIEVE THIS, A PRO-ACTIVE APPROACH, INVOLVING RESPONSIBLE INSPECTION AND MAINTENANCE OF ELECTRICAL INSTALLATIONS, MACHINERY AND APPLIANCES, IS REQUIRED WHICH WILL IDENTIFY AND, AS FAR AS IS REASONABLY POSSIBLE, ELIMINATE OR MITIGATE HAZARDS. THE GREATER THE POTENTIAL HAZARD, THE HIGHER WILL BE THE STANDARD OF PRECAUTIONS REQUIRED. AN EMPLOYER WILL NOT BE ABLE TO HIDE BEHIND HIS OR HER OWN IGNORANCE OR LACK OF EXPERTISE, ESPECIALLY WHEN THE NECESSARY EXPERTISE IS READILY AVAILABLE ELSEWHERE.

## WHAT DOES THE OHS ACT (ACT 85 OF 1993) SAY ABOUT ELECTRICAL COMPLIANCE? (PART 6)

- THE COMMON-LAW DUTY HAS BEEN EXPRESSED AS FOLLOWS:  
“AN EMPLOYER OWES A COMMON LAW DUTY TO AN EMPLOYEE TO TAKE REASONABLE CARE FOR HIS SAFETY. AN EMPLOYER IS IN THE FIRST PLACE UNDER A DUTY TO SEE THAT HIS EMPLOYEES DO NOT SUFFER THROUGH HIS PERSONAL NEGLIGENCE, SUCH AS FAILURE TO PROVIDE A PROPER AND SAFE SYSTEM OF WORKING AND A FAILURE TO PROVIDE PROPER AND SUITABLE PLANT, IF HE KNOWS OR OUGHT TO HAVE KNOWN OF SUCH A FAILURE. IF AN EMPLOYEE IS EMPLOYED ON WORK OF A DANGEROUS CHARACTER, THE EMPLOYER IS BOUND TO TAKE ALL REASONABLE PRECAUTIONS FOR THE WORKMAN’S SAFETY.

Created by ARK Education and Training

## WHAT DOES THE OHS ACT (ACT 85 OF 1993) SAY ABOUT ELECTRICAL COMPLIANCE? (PART 7)

- THE NOTION OF 'SAFE' IS DEFINED AS "FREE FROM ANY HAZARD". 'HAZARD' IN TURN MEANS A "SOURCE OF OR EXPOSURE TO DANGER". IT IS IMPORTANT TO NOTE HOW BROAD AND WIDE-RANGING THESE DEFINITIONS ARE. SUCH BROAD DEFINITIONS TEND TO PLACE AN ONUS ON AN EMPLOYER – ON WHOSE PREMISES AN ACCIDENT HAS OCCURRED – TO SHOW THAT HIS WORKPLACE OR MACHINERY WAS SAFE, AND IT IS DIFFICULT TO IMAGINE ANY WORKPLACE ACCIDENT, OTHER THAN THOSE CAUSED BY EMPLOYEES THEMSELVES, OR SO-CALLED 'FREAK' ACCIDENTS, THAT COULD NOT ARGUABLY BE TRACED BACK TO A 'SOURCE OF DANGER'.

## WHAT DOES THE OHS ACT (ACT 85 OF 1993) SAY ABOUT ELECTRICAL COMPLIANCE? (PART 8)

- THIS CONSIDERATION HAS A CRUCIAL BEARING ON THE TEST APPLIED BY THE COURTS IN DETERMINING WHETHER OR NOT AN EMPLOYER HAS BREACHED THE DUTY OF CARE. THIS IS A TWO-STAGE TEST: FIRSTLY, THE COURT DECIDES WHETHER OR NOT THE ACCIDENT WAS CAUSED BY THE EMPLOYER'S ACT OR OMISSION. IF SO, THE SECOND STAGE APPLIES: DID THE EMPLOYER MEET THE REQUIRED STANDARD OF CARE? IF THE ACCIDENT COULD HAVE BEEN FORESEEN, AND THE EMPLOYER FAILED TO TAKE REASONABLE STEPS TO PREVENT IT, THEN HE WILL NOT HAVE MET THE REQUIRED STANDARD OF CARE AND HE WILL BE LIABLE.

# WHAT DOES THE OHS ACT (ACT 85 OF 1993) SAY ABOUT ELECTRICAL COMPLIANCE? (PART 9)

- IT IS CLEAR FROM THIS THAT THE ACT EXPECTS EMPLOYERS TO ADOPT A PRO-ACTIVE APPROACH TO HEALTH AND SAFETY. THEY ARE REQUIRED TO GIVE CAREFUL CONSIDERATION TO POTENTIALLY HARMFUL MATERIALS, PLANT, EQUIPMENT OR PROCESSES IN THE WORKPLACES, AND TO TAKE REASONABLE STEPS TO RENDER THESE SAFE

# WHAT DOES THE OHS ACT (ACT 85 OF 1993) SAY ABOUT ELECTRICAL COMPLIANCE? (PART 10)

- THE GREATER THE SERIOUSNESS OF THE POTENTIAL HARM OR THE GREATER THE PROBABILITY OF ITS OCCURRENCE, THE GREATER WILL BE THE NECESSITY FOR TAKING SAFETY PRECAUTIONS." GIVEN THAT ALMOST ANY ELECTRICAL INSTALLATION, MACHINE OR APPLIANCE IS CAPABLE OF CAUSING FATAL INJURY, THE MOST THOROUGH PRECAUTIONS WILL BE REQUIRED OF EMPLOYERS WHOSE WORKPLACES CONTAIN SUCH INSTALLATIONS, APPLIANCES OR MACHINES.

# WHAT DOES THE OHS ACT (ACT 85 OF 1993) SAY ABOUT ELECTRICAL COMPLIANCE? (PART 11)

- AS WE HAVE SEEN, THE ACT REQUIRES EMPLOYERS TO BE PRO-ACTIVE AND TO TAKE STEPS TO AVOID WORKPLACE ACCIDENTS. PROPER MAINTENANCE IS UNDOUBTEDLY ONE OF THE MOST ESSENTIAL OF SUCH STEPS. THE REQUIREMENT TO MAINTAIN A SAFE AND HEALTHY WORKPLACE REQUIRES BOTH AN EFFECTIVE SYSTEM FOR MONITORING THE STATE OF THE WORKPLACE AND THE CORRECTION OF ANY SHORTCOMINGS. THE EXTENT AND TYPE OF MAINTENANCE REQUIRED WILL DEPEND UPON THE NATURE OF THE MANUFACTURING PROCESS, THE SUBSTANCES USED AND THE RISKS POSED TO THE HEALTH AND SAFETY OF EMPLOYEES."



# WHAT DOES THE OHS ACT (ACT 85 OF 1993) SAY ABOUT ELECTRICAL COMPLIANCE? (PART 12)

- REGULAR INSPECTION BY QUALIFIED PERSONNEL WILL BE AN IMPORTANT PART OF AN EFFECTIVE MONITORING SYSTEM. SECTION 8(2)(D) OF THE OHS ACT REQUIRES EMPLOYERS TO ESTABLISH WHAT HAZARDS TO EMPLOYEE HEALTH AND SAFETY EXIST IN THEIR WORKPLACES. IT WILL NOT BE AN ACCEPTABLE DEFENCE IN LAW FOR AN EMPLOYER TO SAY THAT, DUE TO IGNORANCE OR LACK OF EXPERTISE, HE OR SHE FAILED TO IDENTIFY OR RECOGNISE SUCH A HAZARD. SUCH AN EMPLOYER WILL BE EXPECTED TO MAKE USE OF OUTSIDE EXPERTISE.

# WHAT DOES THE OHS ACT (ACT 85 OF 1993) SAY ABOUT ELECTRICAL COMPLIANCE? (PART 13)

- IT WILL ALSO NOT BE AN ACCEPTABLE DEFENCE ON THE PART OF THE EMPLOYER THAT HE OR SHE BELIEVED THAT A GIVEN APPLIANCE, MACHINE OR INSTALLATION WAS SAFE. **WHAT MATTERS IS WHETHER OR NOT SUCH A BELIEF WAS REASONABLE AND WHETHER OR NOT THE EMPLOYER TOOK REASONABLE STEPS TO TEST THAT BELIEF**

# WHAT DOES THE OHS ACT (ACT 85 OF 1993) SAY ABOUT ELECTRICAL COMPLIANCE? (PART 14)

- WHO MAY MAKE THE DECISION THAT A FACILITY IS A HAZARDOUS LOCATION? OHS ACT PUTS THE RESPONSIBILITY ON EMPLOYER (**SECTION 8(2)(D) OF THE OHS ACT**)
- **ANYBODY CAN DO RECOMMENDATION AS FAR AS AREA CLASSIFICATION IS CONCERNED IT IS UP TO USER/OWNER/EMPLOYER TO ACCEPT THE RECOMMENDATION**

# WHAT DOES THE OHS ACT (ACT 85 OF 1993) SAY ABOUT ELECTRICAL COMPLIANCE? (PART 15)

- WHAT IS THE METHOD TO BE USED TO CONDUCT A HAZARD LOCATION ASSESSMENT? (*METHOD OF ASSESSMENT – STANDARD*) **PARTICULAR EXPLOSIVE DUST ATMOSPHERES**

THE “INSPECTOR/ CONSULTANT IS GUIDED BY SANS STANDARDS SANS 60079 PART 10-2” (COMBUSTIBLE DUST AREAS) AND SANS STANDARDS SANS 60079 PART 10-1” (GAS VAPOURS AND LIQUIDS) THE REPORT (AREA CLASSIFICATION) WILL INCORPORATE VISUAL INSPECTION AND INTERVIEWS WITH PLANT OPERATORS AND MANAGEMENT (ESPECIALLY IF THE PERSON CONDUCTING THE CLASSIFICATION IS NOT FAMILIAR WITH THE PROCESS / OPERATION OF GRAIN HANDLING AND STORAGE OR PROCESSING/MILLING.

IF DUST IS A MIXTURE OF SUBSTANCES, OR A QUESTION ARISES AROUND MOISTURE CONTENT OR DUST PARTICLE SIZE OR FOR EXAMPLE MAIZE MEAL) THEN A SAMPLE CAN BE SENT FOR EXPLOSIVITY TEST (NOT OFTEN THE CASE WITH GRAIN HANDLING FACILITIES AS THE PROPERTIES OF THE VARIOUS DUST INVOLVED IN THE INDUSTRY HAVE BEEN WELL DOCUMENTED IN MSDS OR SANS 0108. (LIST OF COMBUSTIBLE MATERIAL). EXPLOSIVITY TEST ARE VERY EXPENSIVE, AND WE NORMALLY USE IT FOR COMBINATION DUST OR IN THE MINING INDUSTRY.

# **WHAT DOES THE OHS ACT (ACT 85 OF 1993) SAY ABOUT ELECTRICAL COMPLIANCE? (PART 16)**

- **FREQUENCY OF ASSESSMENT? AREA CLASSIFICATION IS ONLY REQUIRED TO BE DONE ONCE UNLESS PRODUCT CHANGES OR PROCESS CHANGES OR STRUCTURAL CHANGES THAT WILL IMPACT ON THE EXISTING AREA CLASSIFICATION IS MADE.**
- **A PERIODIC INSPECTION OF POTENTIAL EXPLOSIVE ATMOSPHERE AND THE SPECIALIZED ELECTRICAL INSTALLATIONS ARE REQUIRED TO BE DONE AT LEAST EVERY 24 MONTHS AS PER OHS ACT).**

# WHAT DOES THE OHS ACT (ACT 85 OF 1993) SAY ABOUT ELECTRICAL COMPLIANCE? (PART 17)

- **GMR 2 APPOINTMENT: GMR 2 COMPETENCIES**
- **THE FOUR COMPETENCY LEVELS DESCRIBED BY THE GENERAL MACHINERY**

## **REGULATIONS:**

1. LEVEL 1 - CANDIDATES WHO HAVE SERVED AN APPRENTICESHIP IN AN ENGINEERING TRADE, OR HAS HAD AT LEAST FIVE YEARS' PRACTICAL EXPERIENCE IN OPERATION AND MAINTENANCE OF MACHINERY. THE CANDIDATE NEEDS TO HAVE POST QUALIFICATION EXPERIENCE OF NOT LESS THAN ONE YEAR'S EXPERIENCE IN OPERATION AND MAINTENANCE APPROPRIATE TO THE CLASS. THESE CANDIDATES **MAY SUPERVISE MACHINERY THAT HAS GENERATED POWER OF LESS THAN 1200 KW (IN THE CASE OF MECHANICAL) OR LESS THAN 3000 KVA WHERE MACHINERY IS USED SOLELY FOR THE DISTRIBUTION OF ELECTRICITY (IN THE CASE OF ELECTRICAL).**

## GMR 2 COMPETENCIES

- **THE FOUR COMPETENCY LEVELS DESCRIBED BY THE GENERAL MACHINERY REGULATIONS:**

2. LEVEL 2 - CANDIDATES MUST HAVE A MECHANICAL OR ELECTROTECHNICAL (HEAVY CURRENT) ENGINEERING DIPLOMA. THE CANDIDATES MUST HAVE POST QUALIFICATION EXPERIENCE OF NOT LESS THAN TWO YEARS' PRACTICAL EXPERIENCE IN OPERATION AND MAINTENANCE APPROPRIATE TO THE CLASS OF MACHINERY HE IS REQUIRED TO SUPERVISE. THESE CANDIDATES **MAY SUPERVISE MACHINERY THAT GENERATES POWER BETWEEN 1200 KW AND 3000 KW (IN THE CASE OF MECHANICAL) OR 3000 KVA TO 10 000 KVA IN THE CASE WHERE MACHINERY IS USED SOLELY FOR THE DISTRIBUTION OF ELECTRICITY.**

3. LEVEL 3 - CANDIDATES MUST HAVE A BACHELOR'S IN MECHANICAL OR ELECTRICAL ENGINEERING. THE CANDIDATES NEED TO HAVE POST QUALIFICATION EXPERIENCE OF NOT LESS THAN TWO YEARS APPROPRIATE TO THE CLASS OF MACHINERY HE IS REQUIRED TO SUPERVISE. THE CANDIDATE NEEDS TO HAVE PASSED THE GOVERNMENT CERTIFICATE OF COMPETENCY (GCC) FACTORIES AND OHS ACT EXAM. THESE CANDIDATES **MAY SUPERVISE MACHINERY THAT GENERATES POWER ABOVE 3000 KW (IN THE CASE OF MECHANICAL) OR ABOVE 10 000 KVA IN THE CASE WHERE MACHINERY IS USED SOLELY FOR THE DISTRIBUTION OF ELECTRICITY.**

## GMR 2 COMPETENCIES

- **THE FOUR COMPETENCY LEVELS DESCRIBED BY THE GENERAL MACHINERY REGULATIONS:**

4. LEVEL 4 - CANDIDATES MUST BE A CERTIFICATED ENGINEER. THESE CANDIDATES **MAY SUPERVISE MACHINERY THAT GENERATES POWER ABOVE 3000 KW (IN THE CASE OF MECHANICAL) OR ABOVE 10 000 KVA IN THE CASE WHERE MACHINERY IS USED SOLELY FOR THE DISTRIBUTION OF ELECTRICITY.**



# OHS ACT DEFINITIONS

## INSPECTION AUTHORITY:

MEANS ANY PERSON WHO WITH THE AID OF SPECIALIZED KNOWLEDGE OR EQUIPMENT OR AFTER SUCH INVESTIGATIONS, TEST, SAMPLING OR ANALYSES AS HE MAY CONSIDER NECESSARY, AND AFTER WHETHER FOR REWARD OR OTHERWISE ,RENDERS A SERVICE BY MAKING SPECIAL FINDINGS, PURPORTING TO BE OBJECTIVE FINDINGS, AS TO:

(A.) THE HEALTH OF ANY PERSON;

(B.) THE SAFETY OF RISK TO HEALTH OF ANY WORK, ARTICLE, SUBSTANCE, PLANT OR MACHINERY, OR ANY CONDITION PREVALENT ON OR IN ANY PREMISES; OR

THE QUESTION OF WHETHER ANY PARTICULAR STANDARD HAS BEEN OR IS BEING COMPLIED WITH, WITH RESPECT TO ANY WORK, ARTICLE, SUBSTANCE, PLANT OR MACHINERY, OR WITH RESPECT TO WORK OR A CONDITION PREVALENT ON OR IN ANY PREMISES, OR WITH RESPECT TO ANY OTHER MATTER, AND BY ISSUING A CERTIFICATE, STATING SUCH FINDINGS, TO THE PERSON TO WHOM THE SERVICE IS RENDERED.

# WHAT DISTINGUISH NORMAL ELECTRICAL INSTALLATIONS FROM SPECIALIZED ELECTRICAL INSTALLATIONS? (PART 1)

**Hazardous Location REQUIRE SPECIALIZED ELECTRICAL INSTALLATIONS (Ex). These areas are found in parts of a plant but very seldom comprise an entire plant.**

Area in which an explosive gas atmosphere, or an explosive dust atmosphere, or an explosive gas/dust atmosphere is, or may be expected to be present, in quantities such as to require special precautions for the construction, installation and use of equipment is considered a HAZARDOUS LOCATION

AREAS ARE CLASSIFIED INTO ZONED AREAS ( Zone 0,1 AND 2 FOR FLAMMABLE GAS VAPOURS LIQUIDS; AND ZONE 20,21,22 FOR COMBUSTIBLE DUST ATMOSPHERES) is possible to have both types in the agricultural industry combustible dust atmosphere in particular is more profound.

# WHAT DISTINGUISH NORMAL ELECTRICAL INSTALLATIONS FROM SPECIALIZED ELECTRICAL INSTALLATIONS? (PART 2)

SPECIALIZED ELECTRICAL INSTALLATIONS REQUIRE EXPLOSION PROTECTED (Ex) ELECTRICAL EQUIPMENT

SPECIALIZED ELECTRICAL INSTALLATION CAN ONLY BE INSTALLED, MAINTAINED AND REPAIRED UNDER THE CONTROL OF A MASTER INSTALLATION ELECTRICIAN (MIE)

CERTIFICATES OF COMPLIANCE FOR SPECIALIZED ELECTRICAL INSTALLATION CAN ONLY BE ISSUED BY MASTER INSTALLATION ELECTRICIANS

THERE ARE THOSE THAT SAY: ZONING CAN BE TURNED "ON" AND "OFF" SEASONALLY WISE. (HARVEST AND NO HARVEST)

# WHAT DISTINGUISH NORMAL ELECTRICAL INSTALLATIONS FROM SPECIALIZED ELECTRICAL INSTALLATIONS? (PART 3)

- 60 – 85% of dust explosion risk areas in the agricultural industry can be classified as safe areas provided engineering AND OTHER GOOD PRACTICE measures are employed to ensure that a combustible atmosphere and an ignition source does not co-exist
- GOLDEN RULE : **IF YOU CAN CLEAN IT YOU DON'T NEED TO ZONE IT**

## **INCLUDE**

- EDUCATION AND TRAINING SPECIFICALLY DUST EXPLOSION AWARENESS
- DUST SUPPRESSION (SEAL DUST LEAKS)
- DUST EXTRACTION (DUST EXTRACTION SYSTEMS)
- HOUSEKEEPING (NOTHING BEATS A BROOM)
- IN ENCLOSED PROCESS EQUIPMENT (DUST EXTRACTION; BUCKET HOIST BLOW PANELS WILL LIMIT THE RISK TO SAFE LEVELS)



## OLD CHINESE SAYING:

It is better to slay a dragon than to teach people ways to live peacefully with him!!!

## UNSAFE ACTS VS. UNSAFE CONDITIONS

80-85% of all incidents are the result of unsafe acts;

15-20% of all incidents are the result of unsafe conditions.

Question: If true, why are most efforts geared towards unsafe conditions?

Answer: It's easier to deal with unsafe conditions than unsafe acts.



**THIS IS WHAT COULD HAPPEN IF YOU TRY AND  
LIVE A PEACEFUL LIFE WITH A DRAGON,  
INSTEAD OF DEALING (REMOVE IT) WITH THE  
DRAGON**





Created by ARK Education and Training





Created by ARK Education and Training



Created by ARK Education and Training

# WHERE TO BEGIN IF YOU THINK YOU HAVE AREAS IN YOUR PLANT/FACILITY THAT COULD QUALIFY AS HAZARDOUS LOCATIONS THAT WOULD REQUIRE SPECIALIZED ELECTRICAL INSTALLATIONS. (PART 1)

- WHAT SUBSTANCE ARE USED/PRODUCED/STORED HANDLED
- PLANT BASED / AS WELL AS SOME METAL AND MINERAL POWDERS CAN FORM COMBUSTIBLE DUST PRODUCTS FORMING INTO DUST CLOUDS
- FLAMMABLE LIQUIDS, NORMALLY RAW MATERIAL BASE WILL BE FLAMMABLE
- EXCEPTIONS, FOR EXAMPLE WHEN YOU MIX WATER WITH CERTAIN CHEMICALS (CALCIUM CARBIDE) RESULT IS ACETYLENE (VERY DANGEROUS IS ATOMIZED ALUMINIUM POWDER USED AS ROCKET FUEL
- GAS; VAPOURS; MISTS (DIESEL FUEL); LIQUIDS

# WHERE TO BEGIN IF YOU THINK YOU HAVE AREAS IN YOUR PLANT/FACILITY THAT COULD QUALIFY AS HAZARDOUS LOCATIONS THAT WOULD REQUIRE SPECIALIZED ELECTRICAL INSTALLATIONS. (PART 2)

- FERMENTATION PROCESS RESULTING IN GENERATION OF METHANE GAS
- LARGE SCALE BATTERY CHARGING OPERATIONS RESULTING IN THE GENERATION OF HYDROGEN GAS (ONLY WET CELL LEAD ACID TYPE OLD POST OFFICE EXCHANGE BUILDINGS)

## **IF YOU ARE NOT SURE ABOUT THE SUBSTANCE THEN:**

- CONSULT SUPPLIER MANUFACTURER OF RAW MATERIAL AND ASK FOR MSDS OF THE SUBSTANCE
- AS A LAST RESORT YOU CAN HAVE A SAMPLE TESTED FOR EXPLOSIVITY (VERY COSTLEY)
- CHANGE PRODUCT, RAW MATERIAL; PROCESS
- CONSULT WITH SIMILAR INDUSTRY
- HOUSEKEEPING WILL BE A GOOD IDEA IN ANY CASE





Created by ARK Education and Training

## (WORLD WIDE) TYPES OF DUST INVOLVED IN DUST EXPLOSIONS

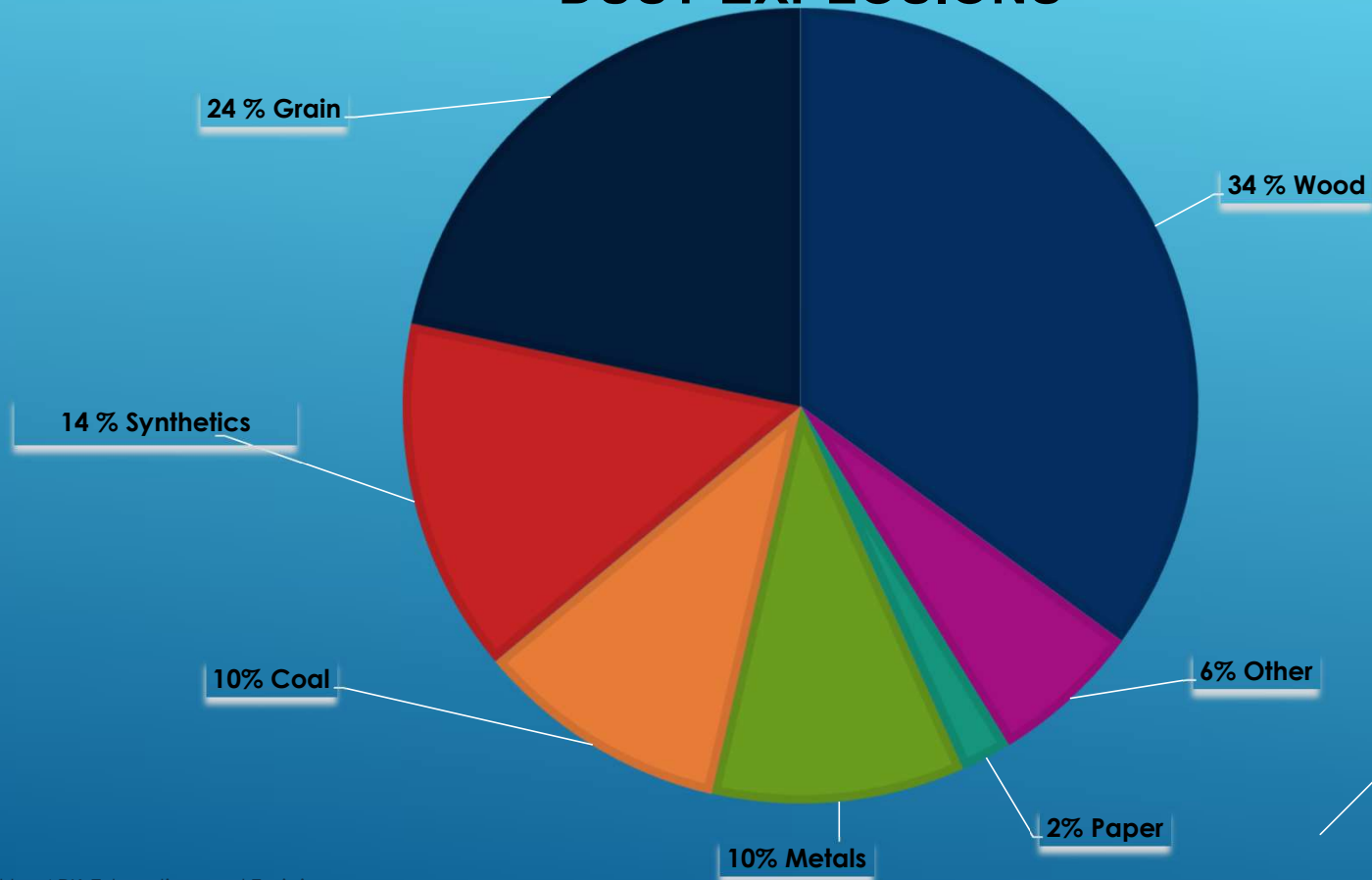

# IGNITION SOURCES OF DUST EXPLOSIONS

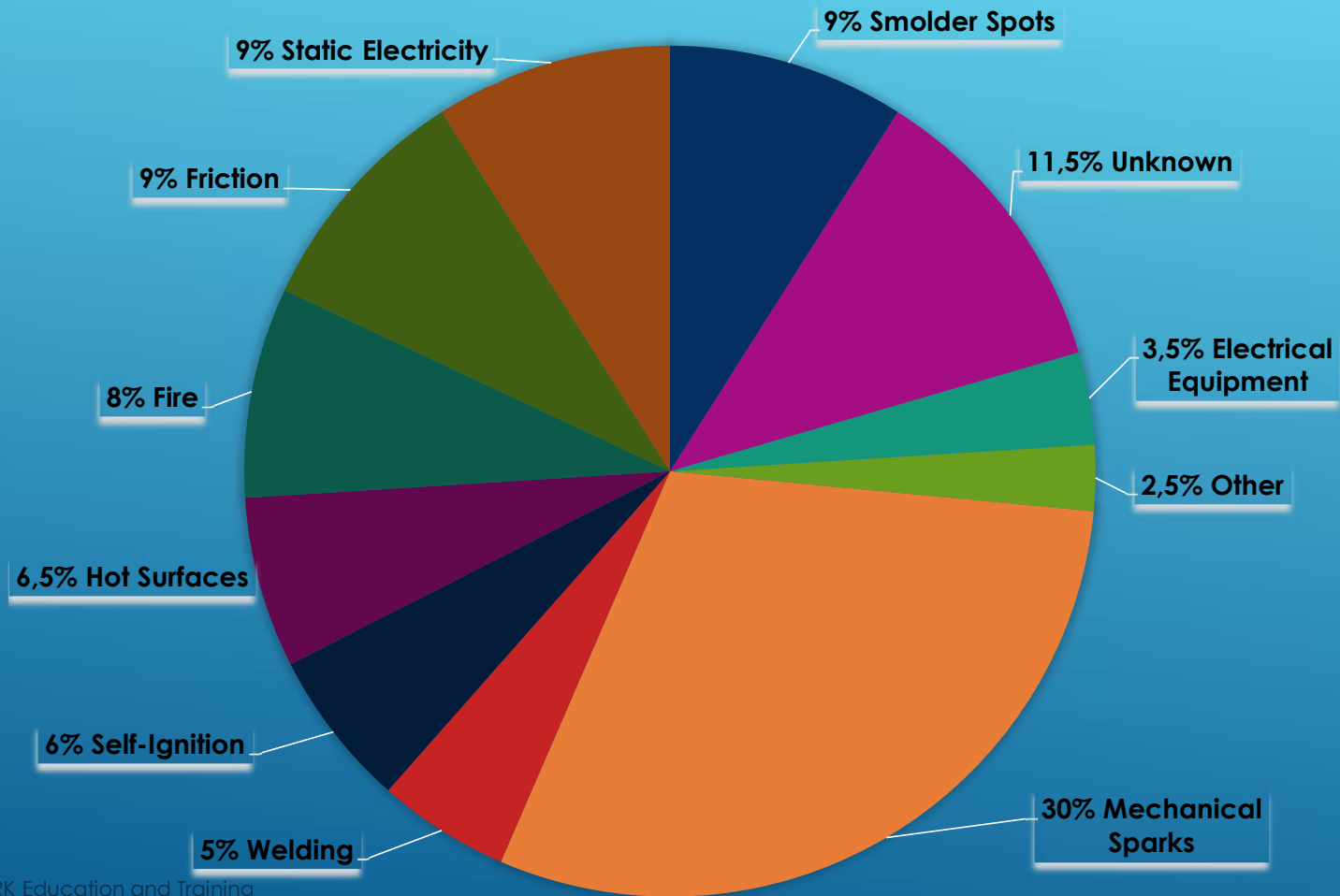



# WHERE TO BEGIN IF YOU THINK YOU HAVE AREAS IN YOUR PLANT/FACILITY THAT COULD QUALIFY AS HAZARDOUS LOCATIONS THAT WOULD REQUIRE SPECIALIZED ELECTRICAL INSTALLATIONS. (PART 3)

## RESPONSIBILITY OF MANAGEMENT

- All Hazardous and Potential Hazardous Locations must be identified as soon as possible , to ensure a safe working environment for all as per Electrical Machinery Regulations 9 (1.)
- This responsibility for Hazardous Locations and their classifications rest with the user (engineer responsible for the plant ) GMR 2(1).
- Engineer may appoint a responsible person under section 2 (7) under the General Machinery Regulations.

### MAJOR HAZARDOUS INSTALLATION versus HAZARDOUS LOCATION

Major Hazardous Installation (MHI):

(a.) where more than the prescribed quantity of any substance is or may be kept, whether permanently or temporarily

(b.) where any substance is produced, processed, used, handled or stored in such a form and quantity that it has the potential to cause a major incident.

# LET'S BREAK

**TYPICAL ELEMENTS INVOLVED IN AN ELECTRICAL COMPLIANCE DRIVE:**  
**A)-ELECTRICAL INSTALLATIONS IN NORMAL ATMOSPHERES**  
**B) ELECTRICAL INSTALLATIONS IN POTENTIAL EXPLOSIVE ATMOSPHERES (PART 1)**

- 1<sup>ST</sup> STEP WILL BE TO ESTABLISH WHICH AREAS HAVE AN EXPLOSION RISK PROFILE (AREA CLASSIFICATION) IF THIS STEP IS INCORRECTLY DONE THE ENTIRE COMPLIANCE DRIVE COULD BE JEOPARDIZED. SPENT GOOD MONEY ON THIS TO GET IT CORRECT, EVEN IF IT REQUIRE MORE THAN ONE OPINION
- THE PERSON THAT DOES THE AREA CLASSIFICATION ONLY MAKES A PROPOSAL TO CLIENT. CLIENT HAS TO ACCEPT THIS.
- EX SPECIALIST TOGETHER WITH VARIOUS DEPARTMENTS SHOULD DISCUSS THE PROPOSAL AND SEE IF AREAS WHICH HAVE BEEN DECLARED ZONED, (AREAS HAVING THE POTENTIAL OF EXPLOSION RISK ATMOSPHERES), WHETHER ENGINEERING MEASURES CAN BE EMPLOYED TO "DE-STRESS" THE ZONING. THESE MEASURES SHOULD BE PRACTICABLE, MEASURABLE, CONSISTENT AND OF COURSE PROVIDE THE NECESSARY OUTCOME. TRAINING HELPS BUT DOES NOT QUALIFY AS AN ENGINEERING MEASURE.

**TYPICAL ELEMENTS INVOLVED IN AN ELECTRICAL COMPLIANCE DRIVE:**  
**A)-ELECTRICAL INSTALLATIONS IN NORMAL ATMOSPHERES**  
**B) ELECTRICAL INSTALLATIONS IN POTENTIAL EXPLOSIVE ATMOSPHERES (PART 2)**

- IF NO ENGINEERING MEASURE HAVE THE DESIRED OUTCOME (NO EXPLOSION RISK) THEN THESE AREAS HAVE TO BE IDENTIFIED USING SIGNAGE (ZONED), AND TRAINING NEEDS TO BE INITIATED (EXPLOSION RISK AWARENESS FOR ALL STAFF) (ZONE 0, 1, 2. ) gas vapours and liquids or (ZONE 20, 21, 22) Combustible dust
- ELECTRICAL EQUIPMENT INSTALLED WITHIN THE ZONED AREAS MUST BE INSPECTED BY A MIE TO DETERMINE WHETHER THE EQUIPMENT COMPLY WITH THE EXPLOSION PROTECTION REQUIREMENTS (EX) OF AN APPROVED SAFETY STANDARD THAT MAKES IT SUITABLE FOR USE IN THESE SPECIFIC ZONED AREAS (TECHNICAL STUFF)
- IF THE AREA CLASSIFICATION (ZONING) WENT WRONG THEN VERY EXPENSIVE EXERCISE TO REPLACE EQUIPMENT

**TYPICAL ELEMENTS INVOLVED IN AN ELECTRICAL COMPLIANCE DRIVE:**  
**A)-ELECTRICAL INSTALLATIONS IN NORMAL ATMOSPHERES**  
**(PART 3)**

- **SANS 10142 PART 1 EDITION 3.1 2021 WIRING OF LOW VOLTAGE ELECTRICAL INSTALLATIONS IS THE FOREMOST STANDARD TO BE USED (ALL SHEQ DEPARTS SHOULD HAVE A COPY IN MY OPINION (HARD OR SOFT))**
- **INSTALLATION ELECTRICIAN SHOULD BE CONTRACTED TO PROVIDE A COST FOR REPAIRS AND THE ISSUE OF THESE CERTIFICATES (CRITICAL THAT FOR EACH ENCLOSURE ONE CERTIFICATE IS PROVIDED)**
- **DON'T CONFUSE ELECTRICAL INSTALLATION COMPRISING OF CIRCUITS ORIGINATING FROM ELECTRICAL DISTRIBUTION BOARDS WITH MOTOR CONTROL CENTERS THAT ARE DESIGNED TO MANAGE /CONTROL VARIOUS PARTS OF EQUIPMENT IN A PLANT.**
- **THESE CONTROL PANELS DOES NOT FORM PART OF THE ELECTRICAL INSTALLATION AS DEFINED BY THE ACT AND HAS TO MEET REQUIREMENTS IN OTHER STANDARDS. THESE CONTROL ENCLOSURES ARE NORMALLY DESIGNED AND POPULATED ON SITE OR ARE SUPPLIED BY A SUPPLIER AS A COMPLETE UNIT. THE ONLY PART OF THE CONTROL ENCLOSURE THAT WILL BE SUBJECT TO A COC IS THE SUPPLY CIRCUIT AND THE CABLES THAT SUPPLY VARIOUS LOADS AS PART OF THE CONTROL ENCLOSURE'S FUNCTION.**

**TYPICAL ELEMENTS INVOLVED IN AN ELECTRICAL COMPLIANCE DRIVE:**  
**A)-ELECTRICAL INSTALLATIONS IN NORMAL ATMOSPHERES**  
**(PART 4)**

- FOR CONTROL ENCLOSURES (MCC) A CONFORMANCE DOCUMENT (**ROUTINE TEST AND INSPECTION CERTIFICATE FOR ASSEMBLY SANS 1973-3**) MUST BE ISSUED
- THE REST OF THE ELECTRICAL INSTALLATION IN NORMAL ATMOSPHERES MUST BE INSPECTED, REPAIRED and tested TO ENSURE COMPLIANCE WITH **SANS 10142 PART 1 Ed 3.1 2021 SECTION 5 (FUNDAMENTALS ONLY)**.
- ALMOST ALL THE ELECTRICAL INSTALLATIONS FOR PURPOSES OF THIS WORKSHOP IS CONSIDERED EXISTING INSTALLATIONS SOME OF THEM VERY OLD THEREFORE THEY WILL NOT MEET ALL THE REQUIREMENTS OF THE 2021 SANS STANDARD. CHALLENGE IS TO FIND OLD ELECTRICIANS THAT KNEW WHAT WAS ALLOWED BACK THEN AND COMPARE THE INSTALLATION WITH THE RULES THAT WERE APPLICABLE BACK THEN.

## TYPICAL ELEMENTS INVOLVED IN AN ELECTRICAL COMPLIANCE DRIVE: **A)-ELECTRICAL INSTALLATIONS IN NORMAL ATMOSPHERES** (PART 5)

- ELECTRICAL COMPLIANCE CAN BE A COSTLY EXERCISE THEREFORE IT IS IMPORTANT THAT THE **PARTICIPANTS/PRACTITIONERS** WHETHER FROM CLIENT SIDE OR CONTRACTOR **ARE WELL ACQUAINTED WITH THE GOALS AND OBJECTIVE. IF CLIENT IS UNSURE RATHER CONSULT AN EXPERT AND MAKE HIM PART OF THE TEAM TO ENSURE VALUE FOR MONEY AND MORE IMPORTANT VALID COC'S.**
- FREQUENTLY HAPPENS THAT CLIENT PAYS TWICE FOR COMPLIANCE WORK SIMPLY BECAUSE HE RELIED ON **THE “BEST PRICE” CONTRACTOR.**
- ELECTRICAL COMPLIANCE IN SPECIFICALLY INDUSTRIAL INSTALLATIONS IS A FINE BALANCE BETWEEN **“REMOVE AND REPLACE” AND “REASONABLY PRACTICABLE SAFE”** SOME REGISTERED PERSONS DON'T WANT TO SIGN COC UNLESS THEY HAVE REPLACED THE INSTALLATION SIMPLY BECAUSE THEY **DON'T UNDERSTAND THE REGULATIONS.**

**TYPICAL ELEMENTS INVOLVED IN AN ELECTRICAL COMPLIANCE DRIVE:**  
**A)-ELECTRICAL INSTALLATIONS IN NORMAL ATMOSPHERES**  
**(PART 6)**

- MAKE SURE YOUR COC AGREEMENT WITH THE REGISTERED PERSON **INCLUDE SOME FORM OF QUALITY CONTROL** MEASURE WHICH WILL VALIDATE WORK DONE. THIS IS PERHAPS IMPORTANT TO INVOLVE THE QUALITY GUY FROM THE ONSET OF THE COMPLIANCE DRIVE.
- AN IMPORTANT FACTOR IS TO MAKE SURE **MAINTENANCE PRACTITIONERS ARE TRAINED IN TERMS OF ELECTRICAL COMPLIANCE. IF NOT, THE “OLD WAYS” WILL SIMPLY JEOPARDIZE THE MONEY AND TIME SPENT ON COMPLIANCE.**
- REGISTERED PERSON KNOWS THAT **IF CHANGES WERE MADE TO AN INSTALLATION** THEY ISSUED A COC FOR THEN THEY ARE **NO LONGER IS RESPONSIBLE** FOR THE CERTIFICATE THAT WAS ISSUED
- CHOOSE YOUR COMPLIANCE “PARTNERS” CAREFULLY AND ALTHOUGH PRICE IS A FACTOR REMEMBER WHAT **NORMAN COLLINS ONCE SAID: GOOD WORK AINT CHEAP. CHEAP WORK AINT GOOD**



**TYPICAL ELEMENTS INVOLVED IN AN ELECTRICAL COMPLIANCE DRIVE:**  
**A)-ELECTRICAL INSTALLATIONS IN NORMAL ATMOSPHERES**  
**(PART 7)**

- IF Electrical compliance IS A LEGAL DECLARATION MADE, SURELY **CLIENT HAS SOME RECOURSE IN THE EVENT ALL IS NOT WELL.**
- YES, SURE YOU CAN APPROACH DEPT OF EMPLOYMENT AND LABOUR TO LAY A COMPLAINT / CHARGE OR YOU CAN APPROACH LOCAL SUPPLY AUTHORITY WHICH EVER THE OUTCOME WILL BE THE SAME;
- THEIR PROTOCOL SAYS “**ELECTRICAL INSTALLATIONS THAT DOES NOT COMPLY MAY NOT BE CONNECTED TO A SUPPLY NETWORK**” GUESS WHAT HAPPENS NEXT. YOU AS THE CLIENT WILL RECEIVE A CONTRAVENTION NOTICE TO MAKE THE INSTALLATION COMPLIANT AND SHOULD YOU FAIL AFTER THE TIME PROVIDED FOR IN THE NOTICE, **THE SUPPLY TO THE INSTALLATION WILL BE DISCONNECTED**, THAT IS OF COURSE PROVIDED THAT NOTHING DANGEROUS IS FOUND.  
**(Annex H NOTIFICATION OF A POTENTIAL DANGER SANS 10142)**

**TYPICAL ELEMENTS INVOLVED IN AN ELECTRICAL COMPLIANCE DRIVE:**  
**A)- ELECTRICAL INSTALLATIONS IN NORMAL ATMOSPHERES**  
**(PART 8)**

- ONCE THE COC (ONE PER DISTRIBUTION BOARD) HAS BEEN ISSUED MAKE SURE THAT YOU **SAVE AN ELECTRONIC COPY**. YOU WILL CRY IF YOU DON'T.
- WE RECOMMEND THAT **REGULAR INSPECTIONS** OF THE ELECTRICAL INSTALLATIONS ARE DONE AS PART OF THE MEASURES TO ENSURE SAFETY ESPECIALLY GIVEN THE **THEFT OF COPPER CABLES AND THE UNLAWFUL TAMPERING WITH ELECTRICAL INSTALLATIONS**.
- IT IS SURPRISING HOW MUCH TIME AND EFFORT IS SPENT ON TESTING EARTH LEAKAGE DEVICES BY PRESSING THEIR BUTTONS NOT REALIZING THAT THE PROTECTIVE CONDUCTOR FOR THE INSTALLATION HAS BEEN REMOVED YEARS AGO REMEMBER PRESSING THE **BUTTON TEST THE DEVICE AND NOT THE PROTECTION OF THE CIRCUIT** WHICH WILL NOT CAUSE THE DEVICE TO OPERATE WITHOUT A PROTECTIVE CONDUCTOR.

**TYPICAL ELEMENTS INVOLVED IN AN ELECTRICAL COMPLIANCE DRIVE:  
B)-ELECTRICAL INSTALLATIONS IN POTENTIAL EXPLOSIVE ATMOSPHERES  
(PART 1)**

- **ELECTRICAL COMPLIANCE IS A LEGAL REQUIREMENT** WHETHER FOR NORMAL OR SPECIALIZED (EXPLOSIVE ATMOSPHERE) TYPE INSTALLATIONS
- HAVING YOUR **AREA CLASSIFICATION PROCESS WELL DOCUMENTED** AND APPROVED IS CRUCIAL ESPECIALLY IF CHANGES ARE MADE TO THE INSTALLATION AND THE ACTUAL REASON WHY THIS **AREA WAS CLASSIFIED OR NOT IN THE BEGINNING MUST BE TRACEABLE.**

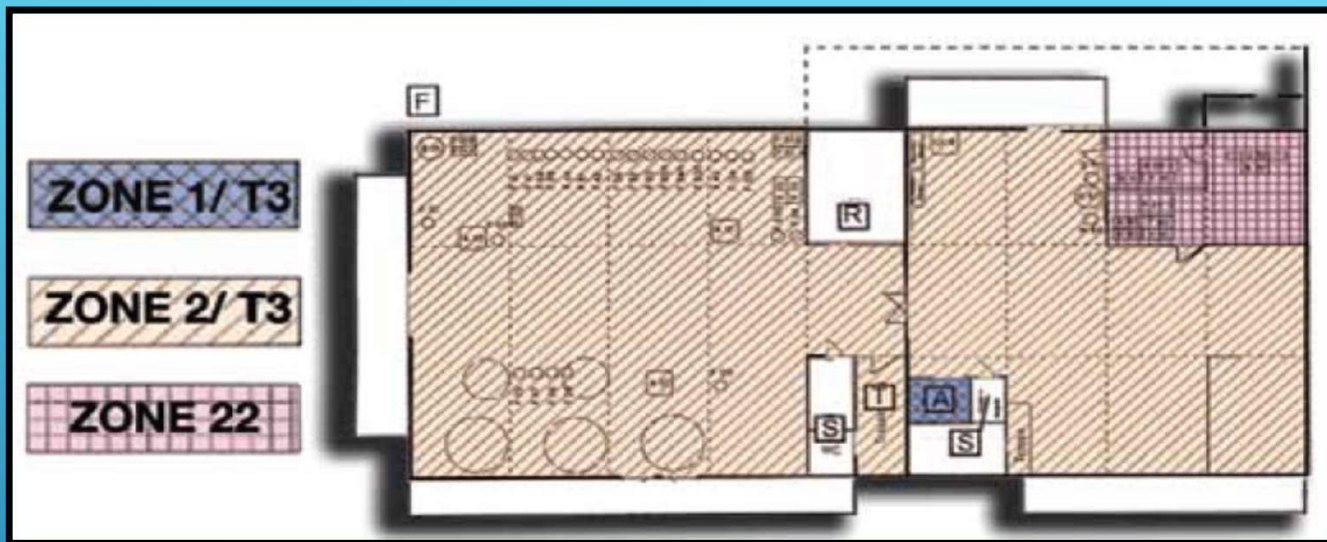

# TABLE

	Zone	Duration of the occurrence of an explosive atmosphere
Gases, vapours, mists	0	continuously, for a long period, frequently
	1	occasionally
	2	rarely and for a short period
Dusts	20	continuously, for a long period, frequently
	21	occasionally
	22	rarely and for a short period

**TYPICAL ELEMENTS INVOLVED IN AN ELECTRICAL COMPLIANCE DRIVE:  
B)-ELECTRICAL INSTALLATIONS IN POTENTIAL EXPLOSIVE ATMOSPHERES  
(PART 2)**

- THE **ENGINEERING MEASURES THAT CAN RENDER THE AREAS SAFE LOCATIONS (DE-STRESS ZONING) MUST BE IMPLEMENTED FIRST**. A **FOLLOW-UP EVALUATION** OF THESE MEASURES ARE CRITICAL TO ENSURE THAT THE REQUIRED COMPLIANCE IS ACHIEVED. IF NOT, THEN THE AREA CLASSIFICATION WILL HAVE TO BE RE-VISITED .
- IF THE ENGINEERING MEASURES DELIVER THE REQUIRED RESULTS (DUST EXPLOSION RISK FREE ATMOSPHERE) , THESE **MEASURES MUST BE TESTED / EVALUATED** AND RECORDS MUST BE KEPT TO PROOF THAT THEY HAVE THE DESIRED EFFECTS WHICH IS, TO **ENSURE DUST EXPLOSION RISK FREE ENVIRONMENT**.

PLANT:				PREVIOUS INSPECTION DATE				DONE BY:			
DATE:			INSPECTION CARRIED OUT BY:						SIGN:		
<p>NOTE: The person responsible for the selection of equipment expects the plant to be free from dust layers; a maximum permissible layer depth of 5 mm on the surface would be acceptable (taking into account any short-term interruption of the cleaning cycle). If a planned level of housekeeping is not maintained, additional fire and explosion risks are created with the result that some equipment may no longer be suitable. ( SANS 61241 PART 10 2005 <i>Electrical apparatus for use in the presence of combustible dust Part 10: Classification of areas where combustible dusts are or may be present</i>)</p>											
Zoning	The rate at which dust is deposited	The grade of release from the source of the dust	The effectiveness of housekeeping (cleaning).	AREAS WITH A SCORE OF 5 OR MORE TO BE A ZONED AREA			Select from options on the left one best describing the current status of the area				
(A)	(B)	(C)	(D)	AREAS	Zone (A)	SCORE	(B)	(C)	(D)		
<b>Safe</b> <b>(≤5)</b>	<b>Low</b> Less than 1mm per shift. Dust in atmosphere not noticeable. On flat surface colour remains unchanged. <b>1</b>	<b>Secondary</b> secondary grade of release: a source which is not expected to release combustible dust during normal operation; if it releases, it is likely to do so only infrequently and for short periods only. <b>1</b>	<b>Good</b> Dust layers are kept to negligible thickness, or are non-existent, irrespective of the grade of release. In this case the risk of the occurrence of explosive dust clouds from layers and the risk of fire due to layers has been removed. <b>1</b>								
<b>Zone 22</b>	<b>Medium</b> More than 1 mm per shift but less than 5 mm per shift. Dust in atmosphere noticeable. <b>2</b>	<b>Primary</b> primary grade of release: a source can be expected to occasionally release combustible dust in normal operation; <b>2</b>	<b>Fair</b> Dust layers are not negligible but are short lived (less than one shift). Depending on the thermal stability of the dust, and the surface temperature of the equipment, the dust may be removed before any fire can start. <b>2</b>								
<b>Zone 21</b>	<b>High</b> More than 5 mm per shift. Dust in atmosphere ever present	<b>Continuous</b> continuous formation of a dust cloud; locations in which a dust cloud may exist continuously, or may be expected to continue for long periods or for short periods which occur frequently; <b>3</b>	<b>Poor</b> Dust layers are not negligible and persist for more than one shift. The fire risk may be significant, <b>3</b>								
<b>Zone 20</b>	<b>3</b>	<b>3</b>	<b>3</b>	<p><b>NOTE: Areas with a score of 5 or more are no longer compliant "SAFE" and have to be re-classified. INSPECTIONS NEED TO BE CARRIED OUT"</b></p>							
				<b>Annual</b>	<b>6 Months</b>	<b>1 Month</b>	<b>Weekly</b>				

**TYPICAL ELEMENTS INVOLVED IN AN ELECTRICAL COMPLIANCE DRIVE:  
B)-ELECTRICAL INSTALLATIONS IN POTENTIAL EXPLOSIVE ATMOSPHERES  
(PART 3)**

- **SELECTING AND INSTALLING EXPLOSION PROTECTED ELECTRICAL EQUIPMENT** IS THE NEXT STEP IN THE COMPLIANCE DRIVE. THIS IS SPECIALIZED WORK
- FOR THE CORRECT SELECTION OF EQUIPMENT IT IS IMPORTANT THAT ONE UNDERSTAND THE NATURE OF THE TWO EXPLOSIONS RISKS (FLAMMABLE GAS VAPOURS, LIQUIDS) (COMBUSTIBLE DUST IN SUSPENSION OR DEPOSITED IN LAYERS).
- TECHNOLOGY IN THE EX FIELD CHANGES ON A 6 MONTH BASIS SO YOUR MIE MUST BE ACQUAINTED WITH THE LATEST TRENDS, REGULATIONS, AND REQUIREMENTS.

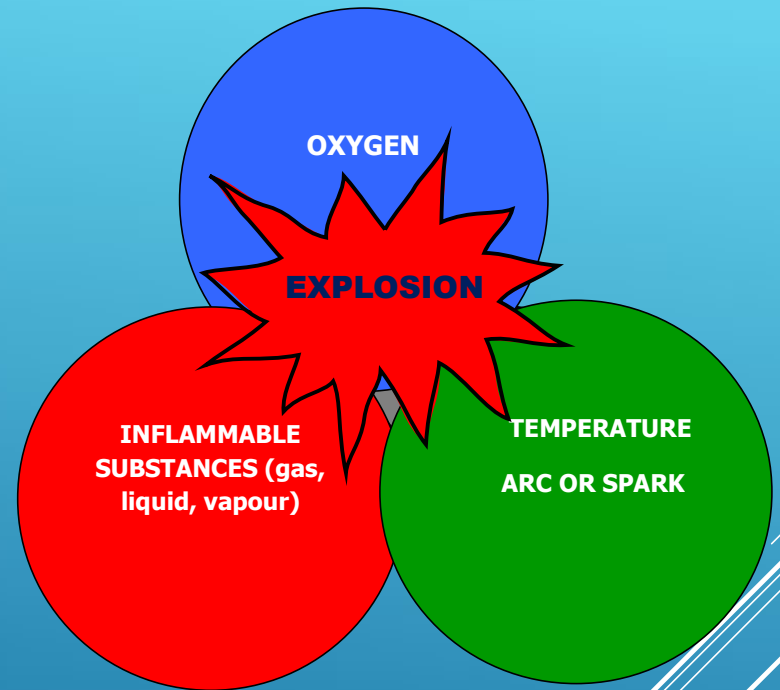
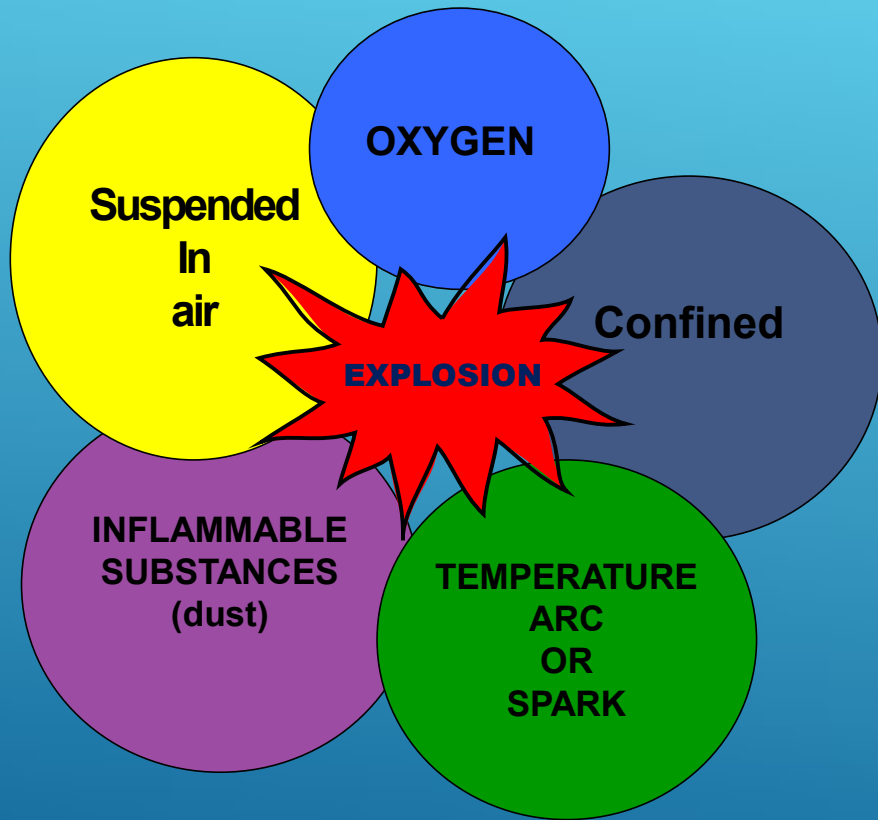



Type of Dust	Maximum Pressure (kPA)	Maximum Rate of Pressure Rise (MPa/s)	Ignition Temperature		Minimum Ignition Energy (J)	Lower Explosive Limit (g/m <sup>3</sup> )
			Cloud (°C)	Layer (°C)		
Maize	655	41.0	400	250	0.04	55
Grain dust, winter wheat, corn, oats	790	38.0	430	220	0,03	55
Soy flour	540	5,5	540	190	0,10	60
Wheat flour	655	26,0	380	360	0,05	50
Wheat straw	680	41.0	470	220	0,05	55

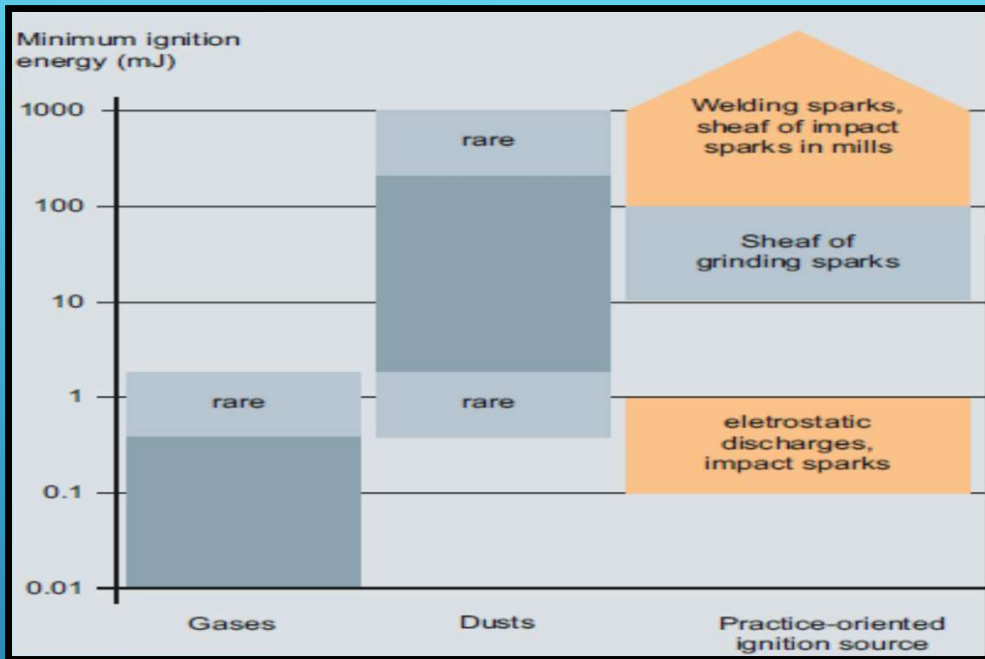

## Hot Surfaces

Hot surfaces can ignite dust explosions in two ways, the first by causing lying dust to burn, and the second by direct contact with the dust cloud. The chances of igniting a dust cloud are less as this requires a surface temperature of over 400 °C to supply enough heat for ignition.

## Heat from Mechanical Impacts

Often referred to as friction sparks, mechanical impacts can cause ignition. This is not to be confused with friction burning (i.e. where a belt slips and slowly heats) which is much less likely to cause an ignition source. Friction sparks can be particularly dangerous if they are between two metals (combinations of aluminum and rust can cause thermal reactions) as these can provide enough heat to start a dust explosion. **These can often be caused by falling objects (such as nuts or bolts) or by moving equipment contacting plant items.**

# PRIMARY AND SECONDARY EXPLOSIONS

THE CONCENTRATIONS NEEDED FOR A DUST EXPLOSION ARE RARELY SEEN OUTSIDE OF PROCESS VESSELS, HENCE **MOST SEVERE DUST EXPLOSIONS START WITHIN A PIECE OF EQUIPMENT (SUCH AS MILLS, MIXERS, SCREENS, DRYERS, CYCLONES, HOPPERS, FILTERS, BUCKET ELEVATORS, SILOS, ASPIRATION DUCTS, AND PNEUMATIC TRANSIT SYSTEMS).**

THESE ARE KNOWN AS PRIMARY EXPLOSIONS.

IT IS IMPORTANT TO NOTE THAT ONE OF THE MAIN **DIFFERENCES BETWEEN THE DUST EXPLOSION AND FLAMMABLE GAS HAZARD** IS THAT GAS/VAPOUR EXPLOSIONS RARELY HAPPEN INSIDE VESSELS DUE TO A LACK OF AIR TO SUPPORT EXPLOSIONS. HOWEVER, WITH DUST IT IS GENERALLY SUSPENDED IN AIR IN PROCESS EQUIPMENT (UNLESS THE VESSELS ARE OPERATED IN PURE NITROGEN ATMOSPHERES), WHICH CAN STILL POSE A PROBLEM WITH METAL POWDERS WHICH CAN ALLOW DUST EXPLOSION CONDITIONS TO OCCUR. THIS CAN THEN CAUSE THE VESSEL TO RUPTURE IF IT HAS INSUFFICIENT PRESSURE RELEASE DEVICES/VENTING OR IF ITS DESIGN PRESSURE IS TOO LOW. VAST AIR MOVEMENT CAUSED BY A RAPTURE OF THE EQUIPMENT RESULT IN DUST DEPOSITS TO BECOME AIRBORNE RESULTING IN A SECONDARY DUST EXPLOSION.

## SECONDARY DUST EXPLOSION PRINCIPLE



Dust settles on flat surfaces

Some event disturbs the settled dust into a cloud

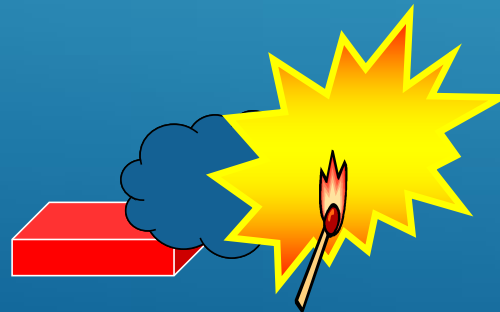
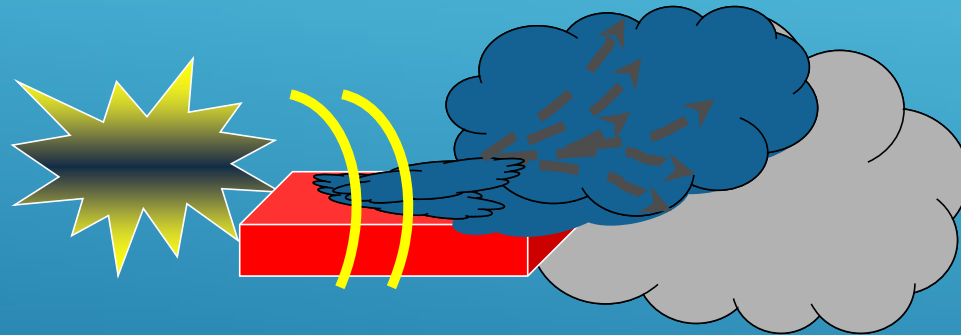

Dust cloud is ignited and explodes

# Cloud Properties that affect the Dust Explosion Hazard

**DUST CHEMISTRY AND MOISTURE CONTENT**

**PARTICLE SIZE AND SPECIFIC SURFACE AREA**

**DUST CONCENTRATION**

**TURBULENCE**

**OXYGEN CONTENT OF OXIDIZING GAS**

**INITIAL DUST CLOUD TEMPERATURE**

**INITIAL PRESSURE OF DUST CLOUD**

**DEGREE OF DUST DISPERSION**

# A Dust Explosion Event

Primary deflagration inside process equipment

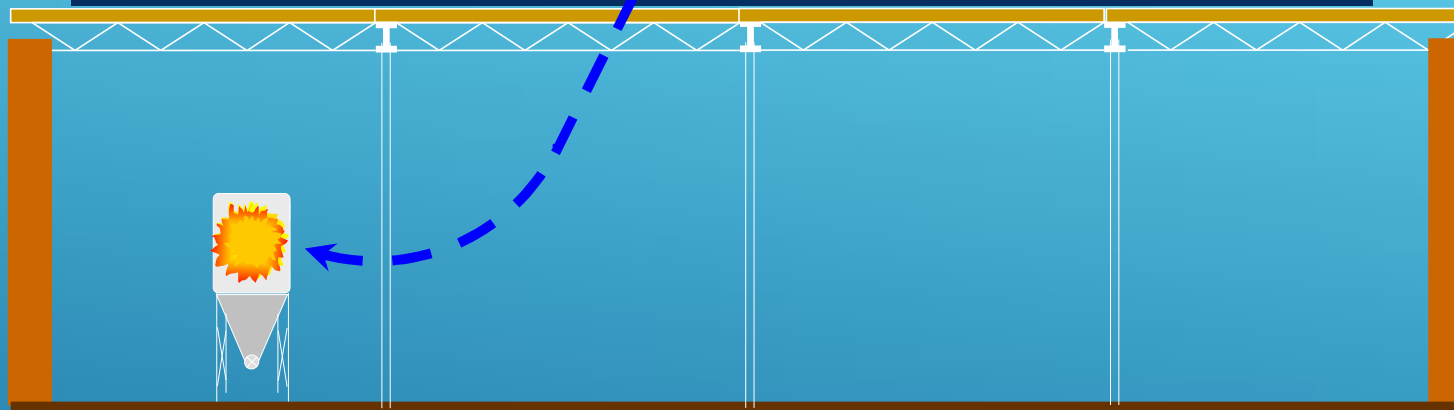

Time, msec.

(Timing of actual events may vary)

# A Dust Explosion Event

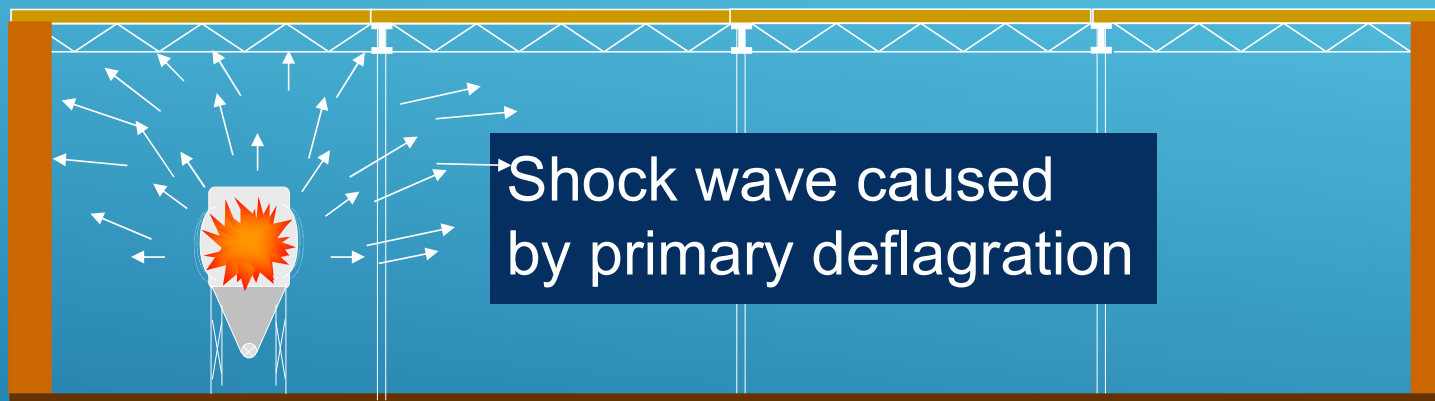

# A Dust Explosion Event

Shock waves reflected by surfaces within the building cause accumulated dust to go into suspension

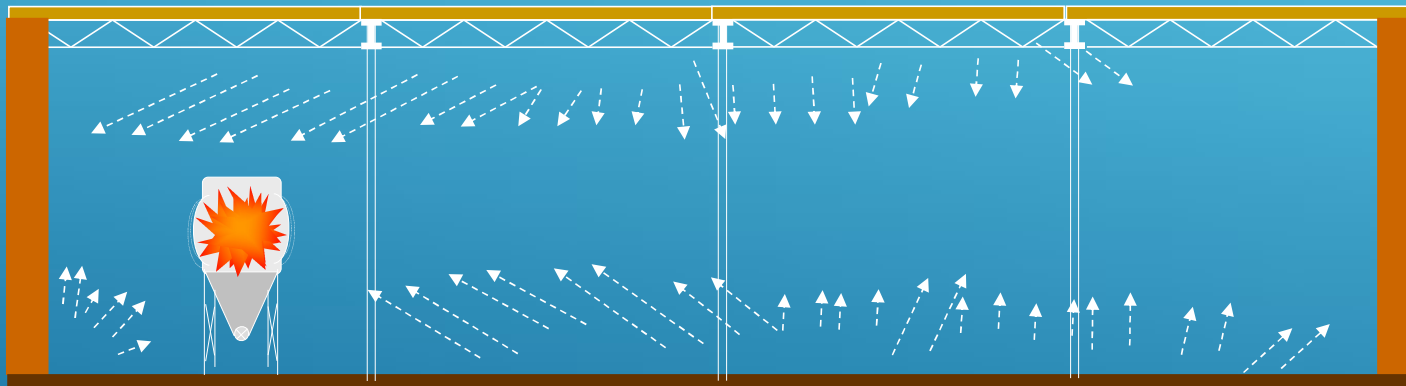



# A Dust Explosion Event

Dust clouds thrown in the air by the shock waves

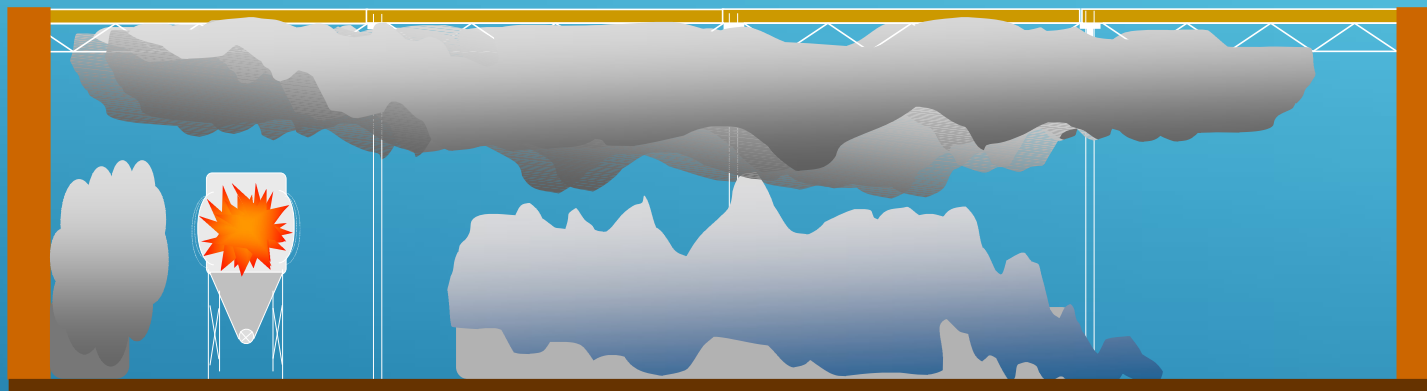

# A Dust Explosion Event

Primary deflagration breaks out of the equipment enclosure - creating a source of ignition

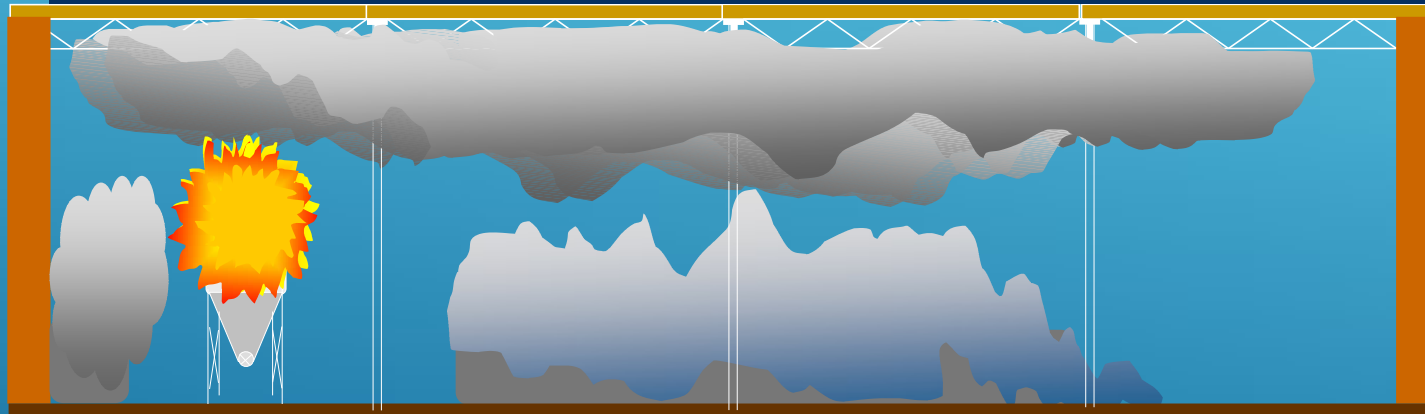

# A Dust Explosion Event

Secondary deflagration ignited

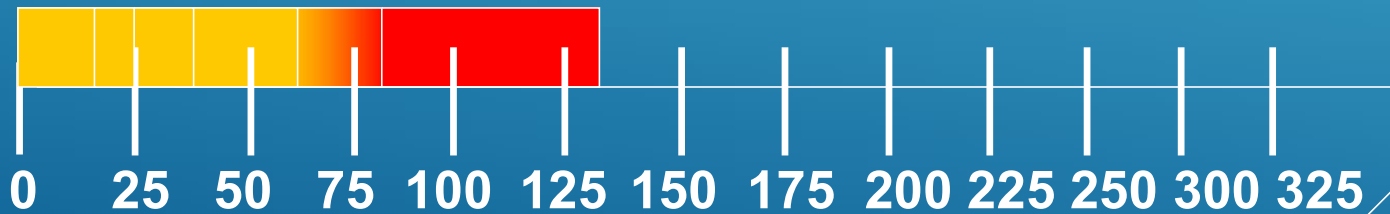
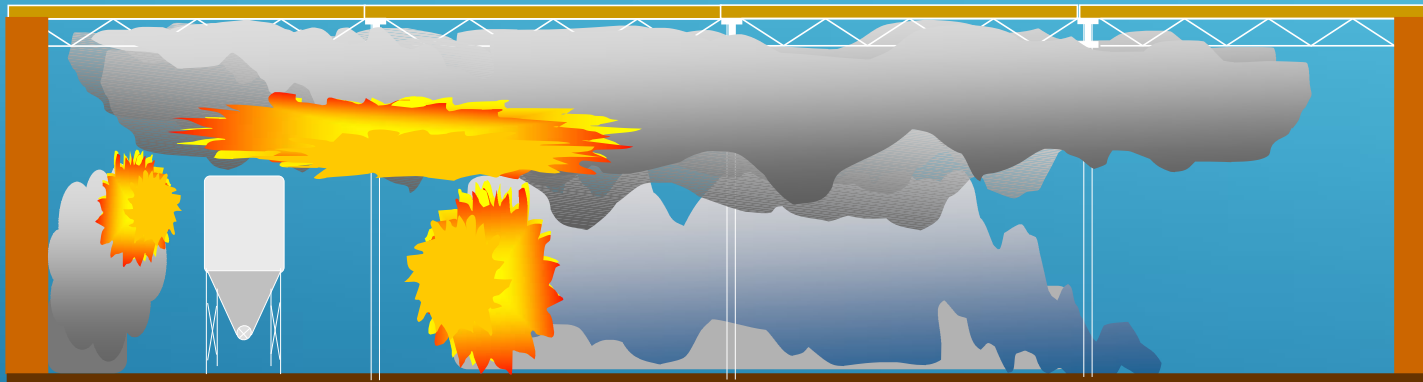

**Time, msec.**

# A Dust Explosion Event

Secondary Deflagration is propagated through the dust clouds

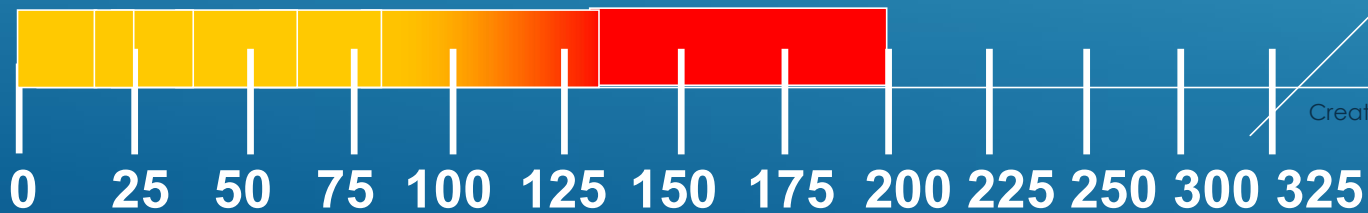
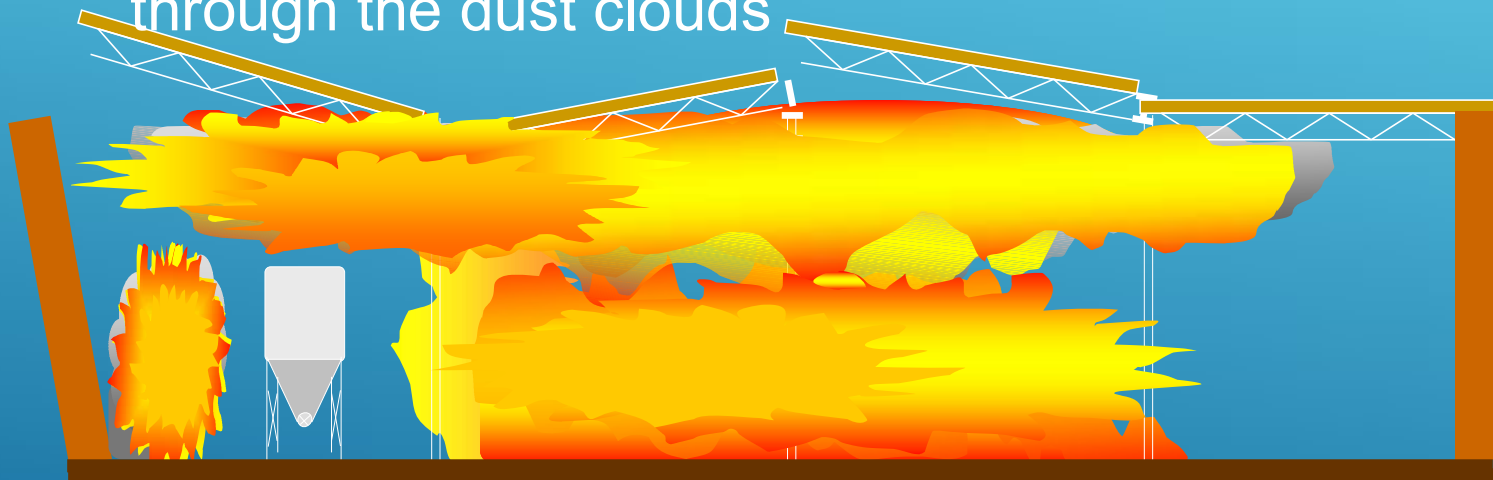

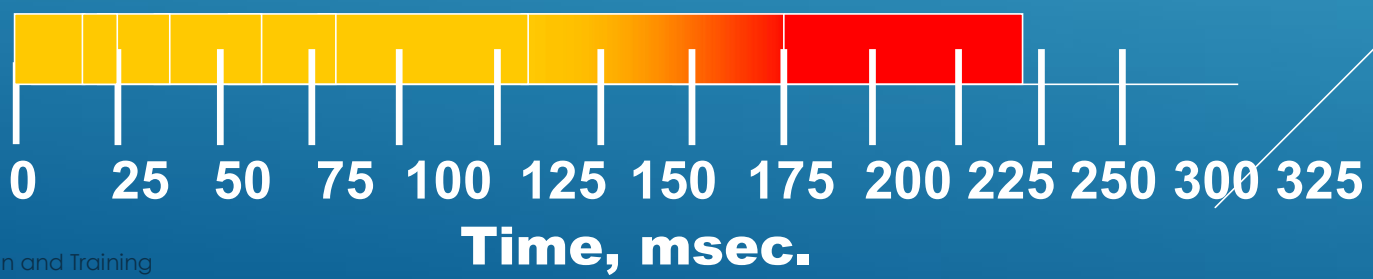
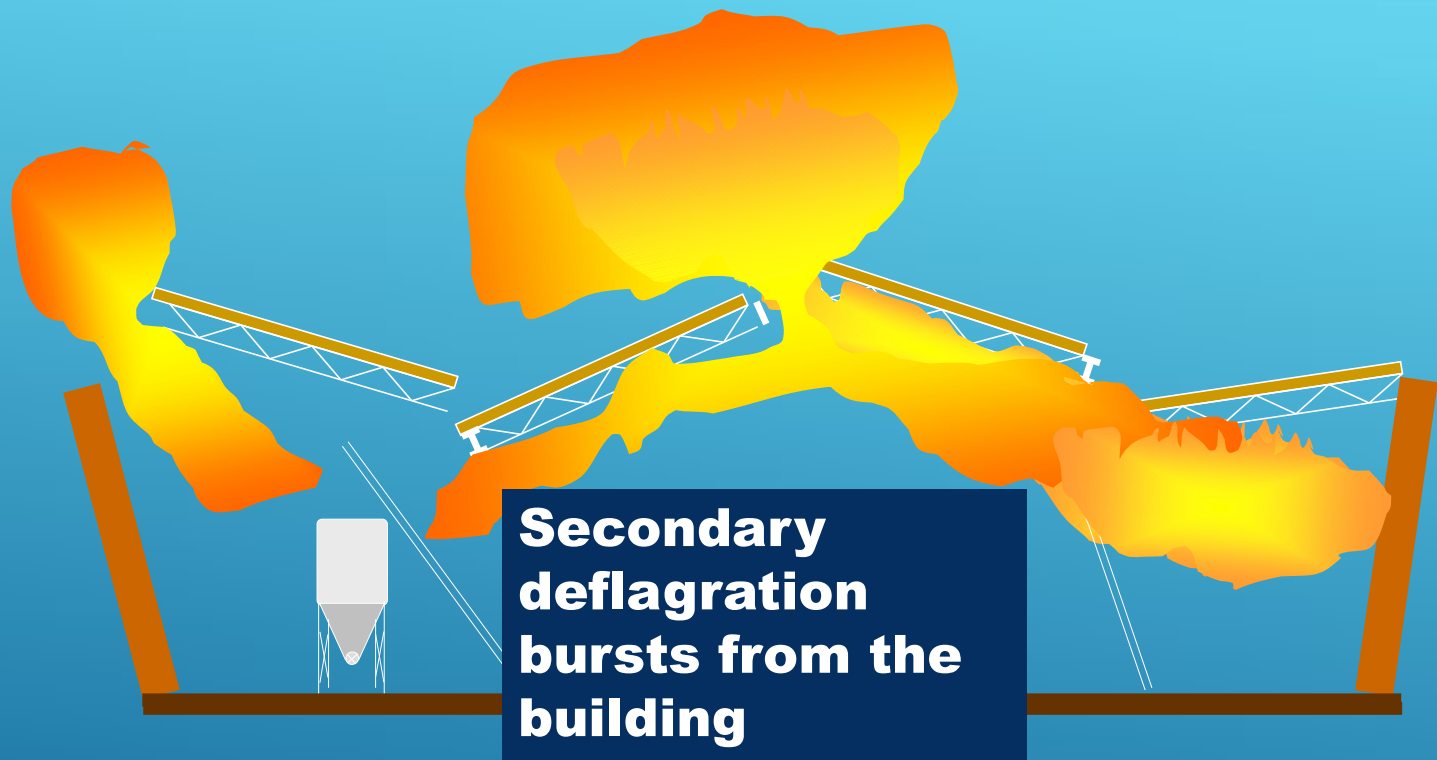

# A Dust Explosion Event

Collapsed building with remaining fires

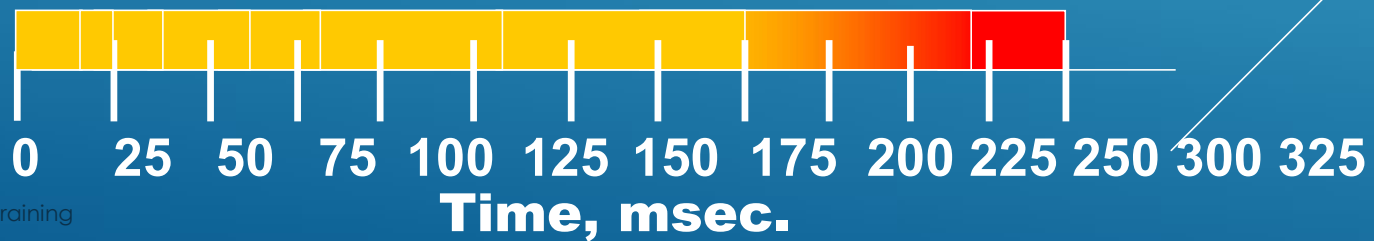
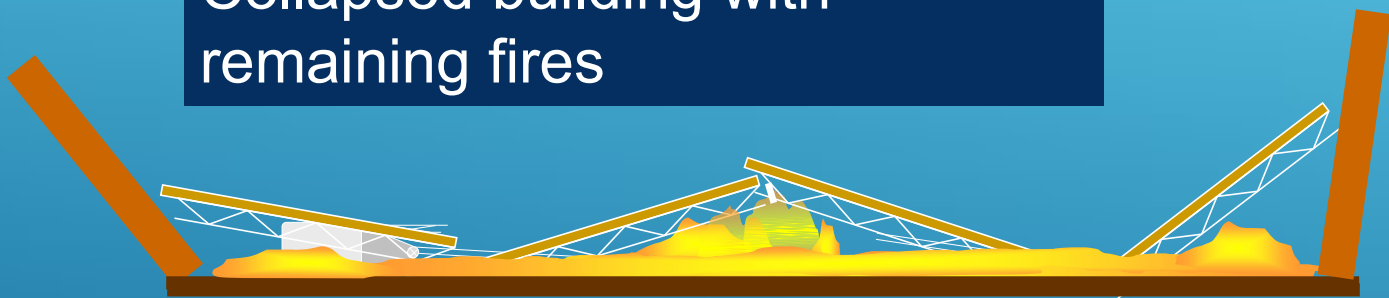

## TYPICAL ELEMENTS INVOLVED IN AN ELECTRICAL COMPLIANCE DRIVE: B)-ELECTRICAL INSTALLATIONS IN POTENTIAL EXPLOSIVE ATMOSPHERES (PART 4)

- SELECTING EXPLOSION PROTECTED SUITABLY RATED FOR THE DIFFERENT CATEGORIES OF EXPLOSIVE ATMOSPHERES IS SOMETHING MIE'S ARE TRAINED FOR.
- CHALLENGE IS THE MIE MAKES HIS CHOICE **BASED ON EXPLOSION RISK BUT NOT NECESSARY ON BEST SUITABLE FOR WORKING ENVIRONMENT**
- EX EQUIPMENT COME IN A VARIETY OF MATERIALS ALL SUITABLE FOR APPLICATION IN A PARTICULAR ZONE BUT SOME ARE MADE FROM MORE DURABLE STRONGER MATERIAL THAN OTHER
- THE MIE NEED TO UNDERSTAND AND **HAVE A BIT OF INSIGHT INTO THE SPECIFIC INDUSTRY FOR HIM TO SELECT THE BEST OPTION** BASED ON ENVIRONMENTAL CONDITIONS AS WELL.

## TYPICAL ELEMENTS INVOLVED IN AN ELECTRICAL COMPLIANCE DRIVE: B)-ELECTRICAL INSTALLATIONS IN POTENTIAL EXPLOSIVE ATMOSPHERES (PART 5)

- SELECTING EXD ELECTRIC MOTORS FOR USE IN A HIGH MOISTURE ATMOSPHERE WILL OFFER A LOT OF CHALLENGES TO CLIENT. IN SUCH A CASE EXE WITH A HIGH IP (INGRESS PROTECTION ) WILL BE MORE SUITABLE.
- THIS WORKSHOP DOES NOT HAVE A FOCUS ON TECHNICAL DETAILS AS FAR AS MARKING AND SELECTING OF EX EQUIPMENT IS CONCERNED.
- LET'S COVER OTHER IMPORTANT ASSOCIATED MEASURES



## IF IN DOUBT, EARTH IT.

These kind of static sparks were long thought to be incapable of igniting a dust cloud, although today they are known to have been the cause of dust explosions where equipment has not been earthed properly. The static electricity build-up in dust processing can be large as charge is transferred from particles to the vessel. There are several different types of electrostatic discharges (Spark, Brush, Corona, Propagating Brush, Surface, and Lightning-like discharge). The most dangerous type are spark discharges, which occur when charge builds up in conducting, unearthed items and is then discharged to earth across a small gap as a spark.

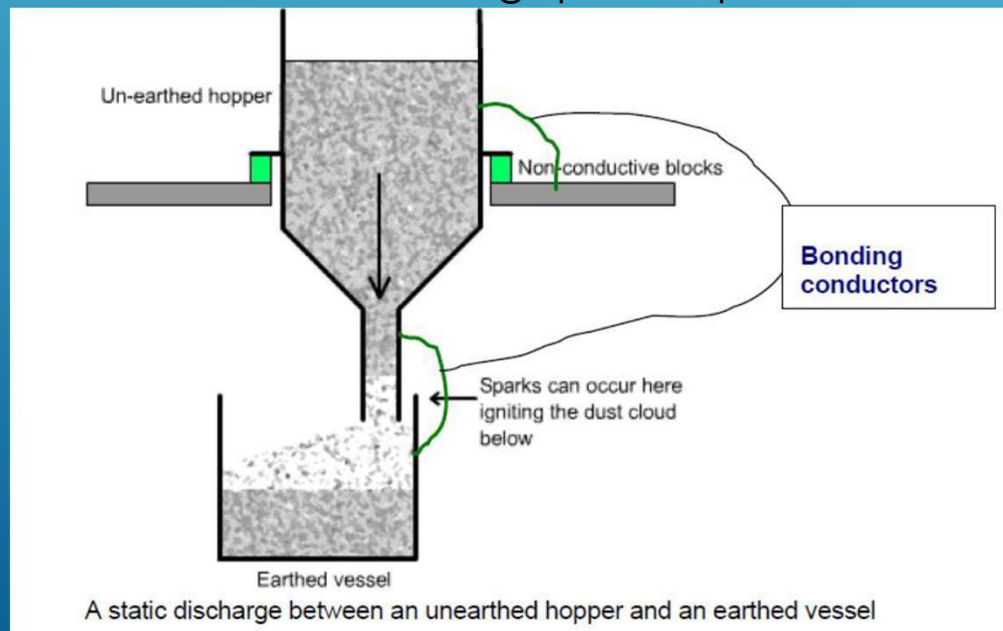

# EARTH PATH STRATEGY

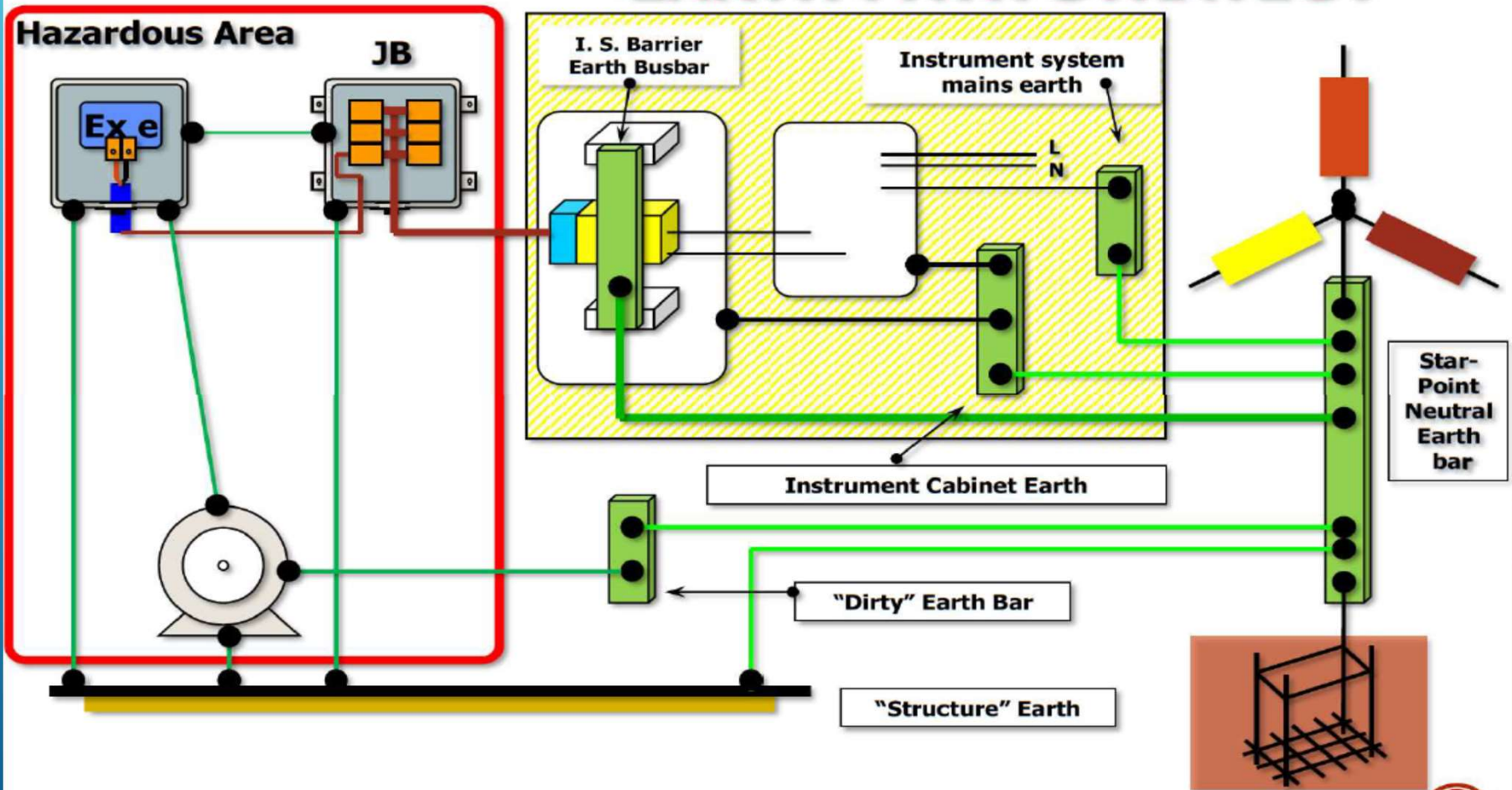

**TYPICAL ELEMENTS INVOLVED IN AN ELECTRICAL COMPLIANCE DRIVE:  
B)-ELECTRICAL INSTALLATIONS IN POTENTIAL EXPLOSIVE ATMOSPHERES  
(PART 6)**

- THE IMPORTANCE OF THE PREVENTION OF UNDESIRABLE STATIC CHARGE BUILD-UP IN POTENTIAL EXPLOSIVE ATMOSPHERES ARE BASED ON THE **RISK OF A SPARK THAT COULD IGNITE AN EXPLOSIVE ATMOSPHERE WHEN DISCHARGE OCCURS.**
- **EX EQUIPMENT MAY NOT BE MODIFIED OR REPAIRED.** EXAMPLE CHANGE EX LUMINAIRES TO LED TYPE.
- **RE-WIND ELECTRIC MOTOR BY A NON ACCREDITED EX REPAIR WORKSHOP ( MUST BE ACCREDITED BY SANAS)**

**TYPICAL ELEMENTS INVOLVED IN AN ELECTRICAL COMPLIANCE DRIVE:  
B)-ELECTRICAL INSTALLATIONS IN POTENTIAL EXPLOSIVE ATMOSPHERES  
(PART 7)**

- ALLOWING A PERSON **NOT TRAINED AND DECLARED COMPETENT TO CARRY OUT MAINTENANCE ON EX EQUIPMENT** WILL RENDER THE CONFORMANCE DOCUMENT AND IA (INSPECTION APPROVED) DOCUMENT NULL AND VOID.
- SPECIALIZED ELECTRICAL INSTALLATIONS MUST BE **INSPECTED AT LEAST ONCE EVERY 24 MONTHS** TO ENSURE THE EQUIPMENT IS STILL IN GOOD WORKING CONDITION.
- EVEN IF NO ZONED AREAS ARE DECLARED THE ENGINEERING MEASURES MUST BE INSPECTED TO ENSURE IT DELIVERS THE REQUIRED PROTECTION AGAINST EXPLOSIVE ATMOSPHERES.

## TYPICAL ELEMENTS INVOLVED IN AN ELECTRICAL COMPLIANCE DRIVE: B)-ELECTRICAL INSTALLATIONS IN POTENTIAL EXPLOSIVE ATMOSPHERES (PART 8)

- HIGH RISK AREAS IN THE AGRICULTURAL INDUSTRY SPECIFIC
- ELECTRICAL COMPLIANCE ARE NOT NECESSARILY THE HIGHEST PRIORITY ON THE SHEQ DEPARTMENT LIST OF THINGS TO DO. YEARS OF ENQUIRIES OF WHETHER CLIENTS ARE IN POSSESSION OF AN AREA CLASSIFICATION DOCUMENT PARTICULARLY IN THE IN THE GRAIN HANDLING / PROCESS FRATERNITY IN THE AGRICULTURAL SECTOR, OR DO YOU HAVE ANY COC'S AT ALL, HAVE TAUGHT ME THIS.
- SAME GOES FOR BULK STORAGE AND HANDLING OF FLAMMABLE FUEL IN ALL SECTORS OF AGRICULTURE.
- GRAIN DRYERS, BACK-UP GENERATORS, BURNERS, INCINERATORS ARE ALL FUEL ENERGIZED EQUIPMENT, SO IT DOES EXIST.
- **MOST PEOPLE ARE CONCERNED ABOUT FLAMMABLE STORES ON THEIR SITES** (NOT SAYING ANYTHING WRONG WITH THAT) BUT IF YOU LOOK AT BUILDERS' WAREHOUSE AND THE AMOUNT OF FLAMMABLE LIQUID THEY KEEP ON THEIR SHELVES.

**TYPICAL ELEMENTS INVOLVED IN AN ELECTRICAL COMPLIANCE DRIVE:  
HIGH RISK AREAS IN THE AGRICULTURAL INDUSTRY SPECIFIC  
(PART 1)**

- THE NEW “THING” **IS OFF THE GRID** WHICH BRINGS IT OWN SET OF CHALLENGES
- SOLAR INSTALLATION ARE PART OF THE SCOPE OF SANS 10142 AND ARE NOT LESS DANGEROUS IF DONE NON-COMPLIANT
- WATER AND ELECTRICITY DOES NOT GO WELL TOGETHER AND **WITH DROUGHTS BECOMING MORE AND MORE RELEVANT PUMP AND IRRIGATION SYSTEMS ARE INSTALLED MORE FREQUENTLY**
- **RESPONSIBLE AGRICULTURE FRAMEWORK IN ORGANIZED AGRICULTURE** IN MY OPINION SHOULD ALSO BE TRANSPLANTED TO FARMERS AND OTHER PRACTITIONERS.
- COMPLIANCE TO STATUTORY REQUIREMENTS AND THE OHS ACT FORMS PART OF THAT FRAMEWORK.
- **ELECTRIC FENCE MEASURES AS A DETERRENT** AGAINST TRESPASSING ARE CREATING A LOT MORE RISK FOR PARTICIPANTS IN THE AGRICULTURAL INDUSTRY
- **Lack of RURAL DEVELOPMENT AND THE PROBLEM OF SCARES SKILLS** MAKE ELECTRICAL COMPLIANCE A HUGE CHALLENGE FOR THIS INDUSTRY.

# SUMMARY

**MY OBSERVATION AFTER YEARS OF INSPECTIONS, CONSTRUCTION, CERTIFICATION, CONSULTATION, RESEARCH AND TRAINING IN THE ELECTRICAL COMPLIANCE INDUSTRY (Ex as well as NORMAL) HAVE TAUGHT ME THE FOLLOWING:**

1. MOST Ex-INFORMATION ON THE WWW DEALS WITH GASES VAPOURS AND LIQUIDS, YET NOT EVERYBODY THAT EATS USES REFINED PETROLEUM PRODUCTS.
2. DID YOU KNOW THERMOBARIC WEAPONS WORKS ON THE FOLLOWING PRINCIPLE: RAPIDLY SATURATING AN AREA WITH AN EASILY COMBUSTIBLE MATERIAL AND THEN IGNITING IT TO PRODUCE EXPLOSIVE FORCE. THESE WEAPONS ARE THE MOST POWERFUL NON-NUCLEAR WEAPONS IN EXISTENCE.
3. FIERY MINES AND INDUSTRIAL FLAMMABLE LIQUID VAPOR AND GAS INDUSTRIES HAVE VERY BIG EXPLOSION PREVENTION RESEARCH FACILITIES IN THE WORLD YET NOT MUCH IS KNOWN ABOUT THE RISK WHICH AFFECT ORDINARY FARM WORKERS AND DUST PLANT OPERATORS
4. USA HAD A MAN WALKING ON THE MOON IN July 1969
5. YET, SUPPORT FOR A COMBUSTIBLE DUST STANDARD CAME FROM THE U.S. (USA) CHEMICAL SAFETY BOARD ONLY IN 2006 AND AGAIN IN 2008 DURING A CONGRESSIONAL HEARING WHEN THE BOARD SAID A NEW STANDARD, COMBINED WITH ENFORCEMENT AND EDUCATION, COULD SAVE WORKERS' LIVES.



**MY OBSERVATION AFTER YEARS OF INSPECTIONS, CONSTRUCTION, CERTIFICATION, CONSULTATION, RESEARCH AND TRAINING IN THE ELECTRICAL COMPLIANCE INDUSTRY (Ex as well as NORMAL) HAVE TAUGHT ME THE FOLLOWING:**

6. THE MARKET FOR DUST EXPLOSION PREVENTION ELECTRICAL EQUIPMENT IS SMALL IN COMPARISON WITH GAS VAPOURS AND LIQUIDS MARKET. SO, THE Ex ID-EQUIPMENT INDUSTRY WILL NOT INVEST HEAVILY IN A MARKET THAT DOES NOT SELL BIG NUMBERS
7. WITH AGRICULTURAL AND SPECIFIC GRAIN HANDLING INFRASTRUCTURE LARGELY BASED IN RURAL AREAS AND MOST OF THE MILLING ( LINKED TO AGRICULTURAL) IN MORE COMMERCIALIZED INDUSTRIAL AREAS, SKILLS THAT CAN DEAL WITH THE PREVENTION OF DUST EXPLOSION RISKS IN RURAL AREAS IS A CHALLENGE. MOST FARMERS SIMPLY HAVE TO “MAAK A PLAN”
8. IF THE AGRICULTURAL/GRAIN HANDLING INDUSTRY WITH ITS GENERIC RELATED COMBUSTIBLE DUST ATMOSPHERES PROCESSES IS THE STEPCHILD OF THE EXPLOSION PREVENTION INDUSTRY. WHO WILL HEIGHTEN ITS STATUS FROM STATUTORY APPLICABLE (OHS Act Act 85 of 1993) TO OWNERSHIP, AS OWNERSHIP IS THE ONLY LONG LASTING SOLUTION TO TURN AROUND THE LACK OF COMPLIANCE. I DON'T THINK WE CAN WAIT TILL WE HAVE A MAN ON THE MOON BEFORE WE TAKE THE MATTER SERIOUSLY ?
9. BEING INVOLVED WITH THE DEPT. of EMPLOYMENT and LABOUR AND Dept of EDUCATION (EXAMINER) WIRING CODE AND SPECIALIZED ELECTRICAL CODES EXAMS, THE KNOWLEDGE ON Ex ESPECIALLY DUST RELATED ASPECTS OF THE Ex-INDUSTRY IS NOT TESTED AS THERE IS NO PLATFORM AVAILABLE TO CULTIVATE THIS KNOWLEDGE.

**MY OBSERVATION AFTER YEARS OF INSPECTIONS, CONSTRUCTION, CERTIFICATION, CONSULTATION, RESEARCH AND TRAINING IN THE ELECTRICAL COMPLIANCE INDUSTRY (Ex as well as NORMAL) HAVE TAUGHT ME THE FOLLOWING:  
HOW TO CHANGES THIS**

10. DIRECTION MUST COME FROM **INDUSTRY SPECIFIC STRUCTURE/ORGANIZATION** TO MAKE A CHANGE.
11. DEVELOP NATIONAL **"BEST PRACTICE CODES"** SIMILAR TO (USA) FOR MAINTAINING SAFE WORKING ENVIRONMENTS,  
THIS IS NOT TO REPLACE NATIONAL, APPROVED SAFETY STANDARDS BUT TO ENHANCE THE REQUIREMENTS STIPULATED IN THE STANDARDS WITH EXPLANATIONS AND DESCRIPTIONS OF WORKPLACE RELATED ACTIONS AND ACTIVITIES.

LET'S NOT TALK OF COMPETITIVE EDGE WHEN IT COMES TO THE HEALTH AND SAFETY OF WORKPLACES WITH SIMILAR RISKS AND CHALLENGES

12. DUST EXPLOSION RISK AWARENESS TRAINING PROGRAMS FOR THE AGRICULTURAL / GRAIN HANDLING INDUSTRY EMPLOYEES AND PRACTITIONERS (FARMERS, TRANSPORTERS, MAINTENANCE CONTRACTORS) AS WELL ELECTRICAL COMPLIANCE FOR ALL OTHER SECTORS THAT DON'T HAVE POTENTIAL EXPLOSIVE ATMOSPHERES BUT ARE USING ELECTRICAL ENERGY ARE, AS FAR AS MY KNOWLEDGE IS CONCERNED ALMOST NON- EXISTING AND IF IT DOES IT IS NOT INDUSTRY SPECIFIC. PERHAPS I AM WRONG
13. CREATE / ESTABLISH A DUST EXPLOSION PREVENTION OFFICER POSITION **"endorsed" for Non-MINING RELATED INDUSTRIES only.** SHOULD BE INVOLVED IN REGULAR INSPECTIONS AND ALSO ACT IN AN ADVISORY CAPACITY TO MEMBERS / OF ORGANIZED INDUSTRY SECTOR (AGRICULTURAL GRAIN AND SPECIFIC DRY RELATED PRODUCTS).

**MY OBSERVATION AFTER YEARS OF INSPECTIONS, CONSTRUCTION, CERTIFICATION, CONSULTATION, RESEARCH AND TRAINING IN THE ELECTRICAL COMPLIANCE INDUSTRY (Ex as well as NORMAL) HAVE TAUGHT ME THE FOLLOWING:  
HOW TO CHANGES THIS**

**(14) WHO SHOULD BE INVOLVED AND WHAT EXISTING PLATFORMS EXIST FOR ENGAGEMENT REGARDING ELECTRICAL COMPLIANCE IN AGRICULTURAL SECTOR**

15. ECA SA (ELECTRICAL CONTRACTORS ASSOCIATION OF SOUTH AFRICA)
16. AMEU ASSOCIATION OF MUNICIPAL ELECTRICITY UTILITIES
17. SAFA (SOUTH AFRICAN FLAME PROOF ASSOCIATION)
18. SABS SOUTH AFRICAN BUREAU OF STANDARDS
19. ORGANIZED LABOUR
20. MANUFACTURERS, SUPPLIERS AND DISTRIBUTORS OF GRAIN HANDLING INFRASTRUCTURE PRODUCTS AND EQUIPMENT FOR EXAMPLE, AIR HANDLING AND DUST EXTRACTION, GRAIN STORAGE, MILLING
21. INSURANCE COMPANIES
22. SPECIALIST INVOLVED WITH INDUSTRIES RELATED TO SUGAR DUST, COTTON DUST, CORN STARCH DUST, ANIMAL FEED DUST , SAWMILL AND WOOD WORKING OPERATIONS, FLOUR PRODUCERS, GRAIN TRANSPORTING GRAIN STORAGE , GRAIN HANDLING
20. JOIN DUST Ex RESEARCH, A COMPANY WITH A WORLD-WIDE FOCUS ON INCREASING AWARENESS OF COMBUSTIBLE DUST HAZARDS AND REDUCING PERSONAL AND FINANCIAL LOSS FROM FIRE AND EXPLOSION INCIDENTS.

# END

- ▶ Pieter Dempsey
- ▶ Ark Education and Training

(Part of ARK Holdings Group)

**My interest is in the future because I'm going to spend the rest of my life there.**

Charles. F. Kettering

